

▶ 3/4" Colored Polycarbonate Corner Guards

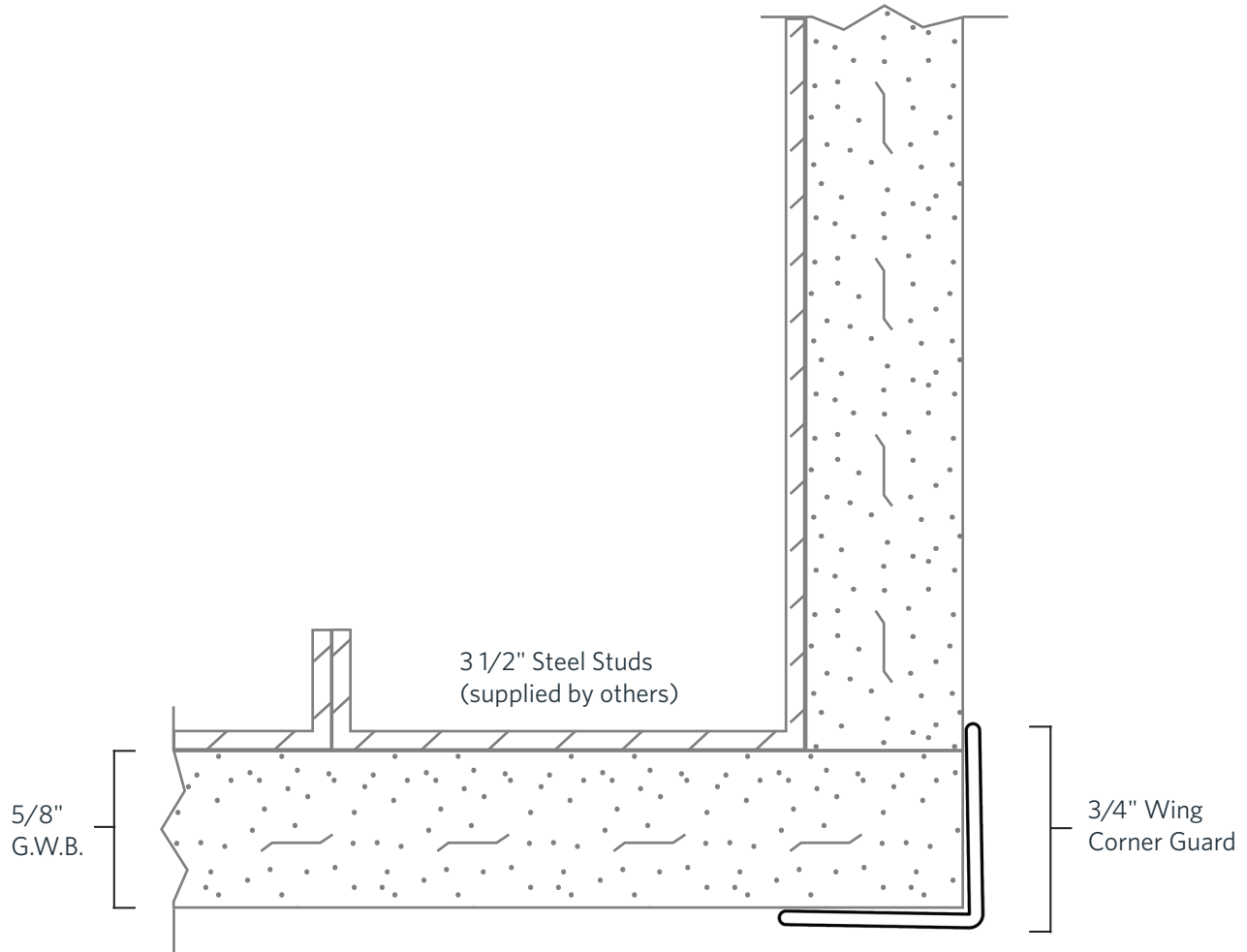

▶ 1 1/2" Colored Polycarbonate Corner Guards

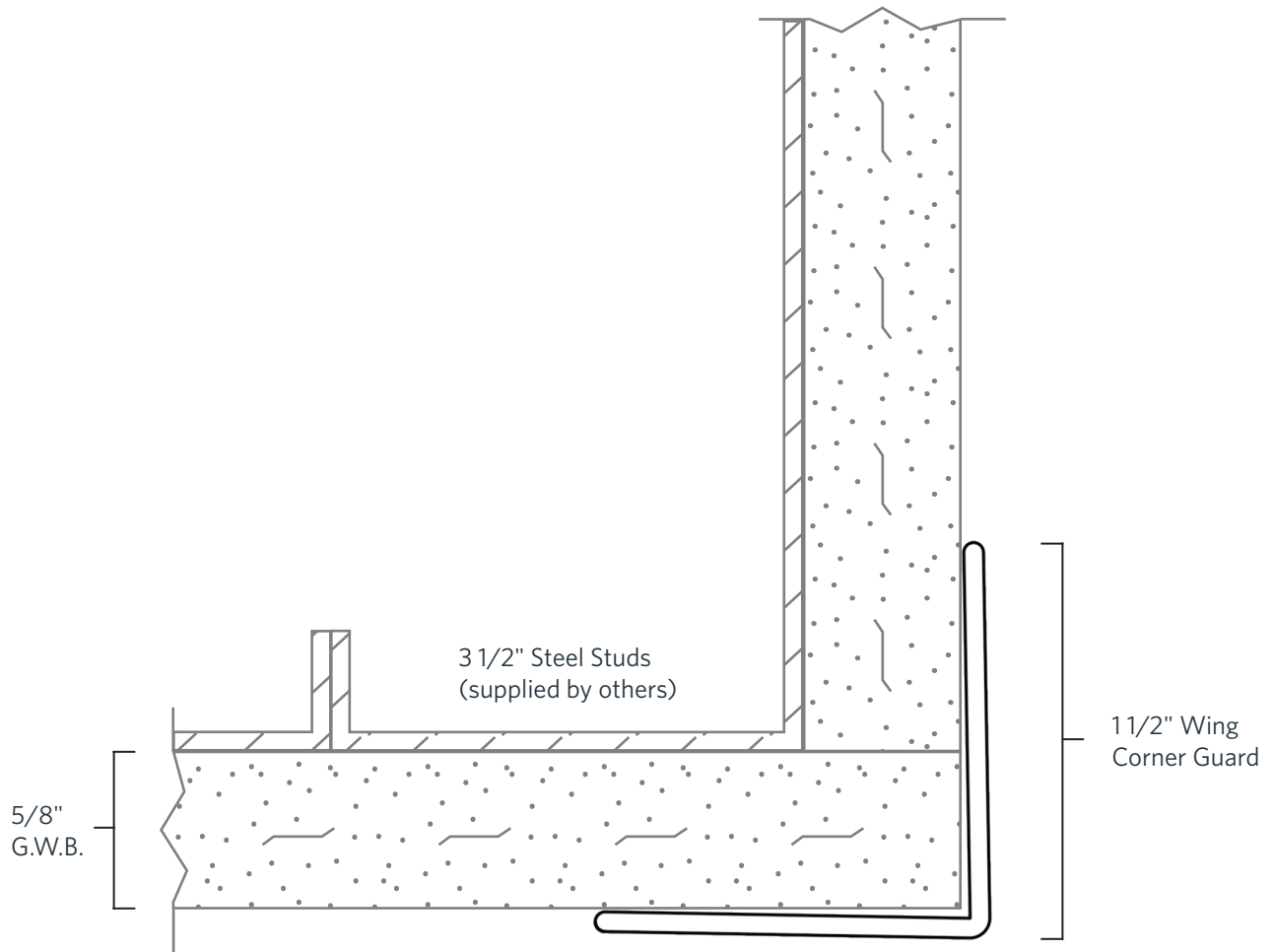

▶ 1 1/8" Colored Polycarbonate Corner Guards

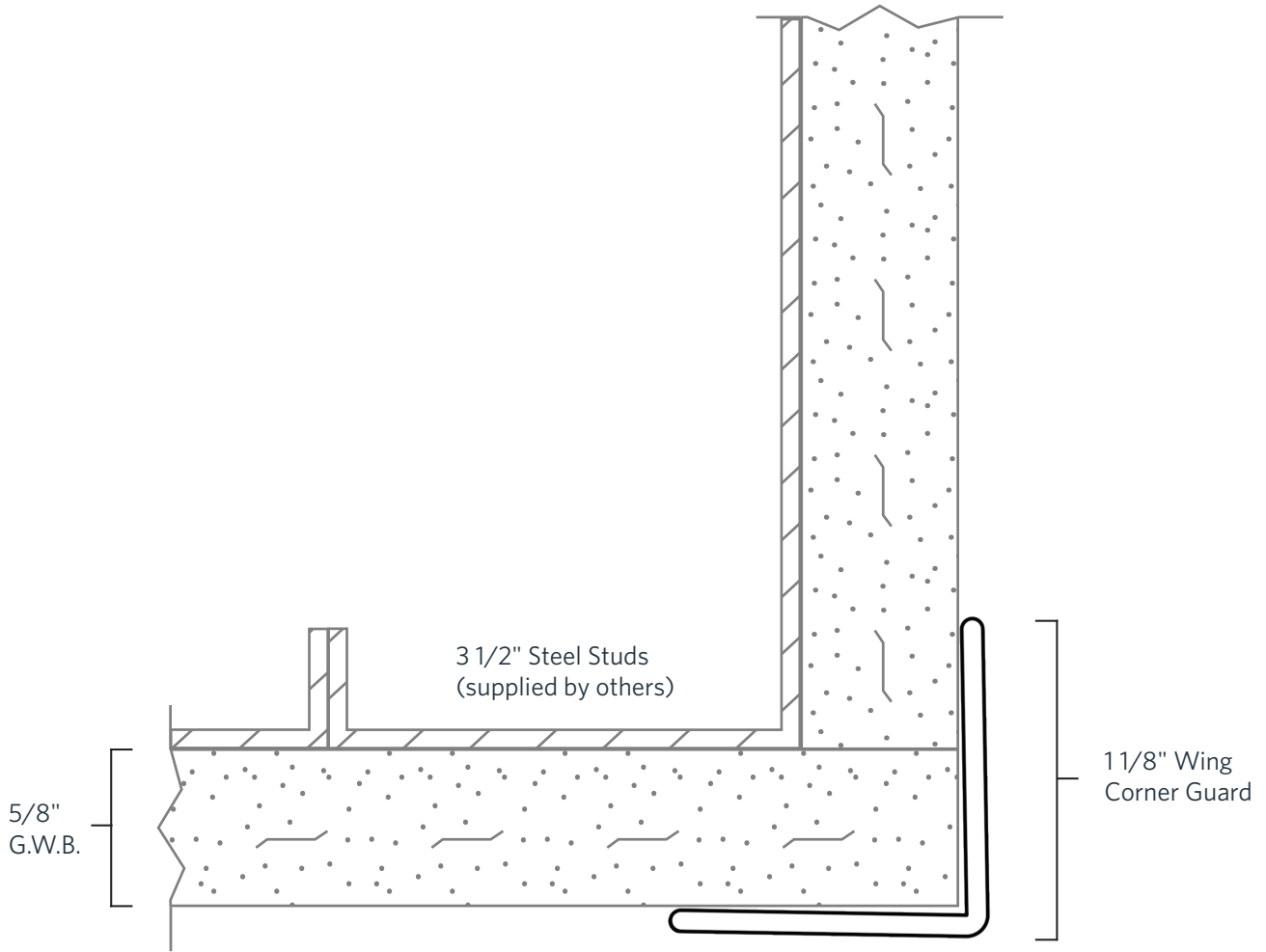

CAD DRAWING

▶ 2 1/2" 135° Colored Polycarbonate Corner Guards

WX2

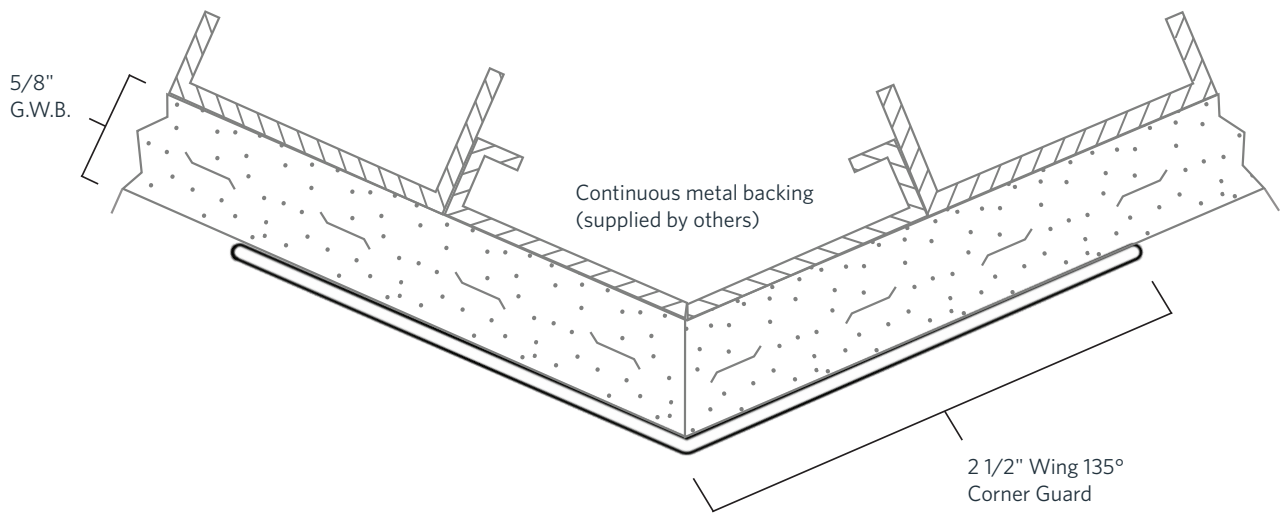

CAD DRAWING

▶ 2.5" Bullnose Colored Polycarbonate Corner Guards wx2

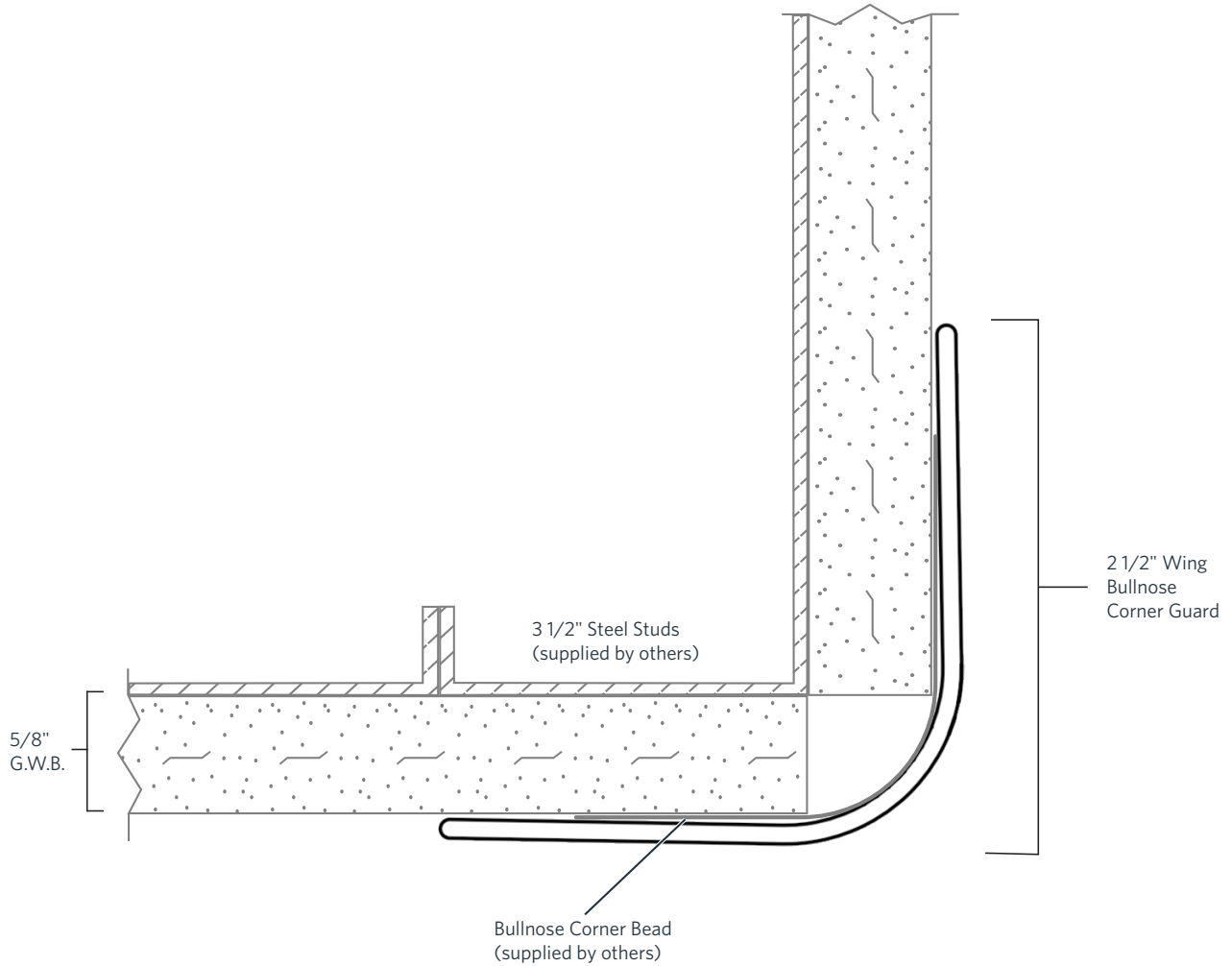

▶ 2 1/2" Colored Polycarbonate Corner Guards

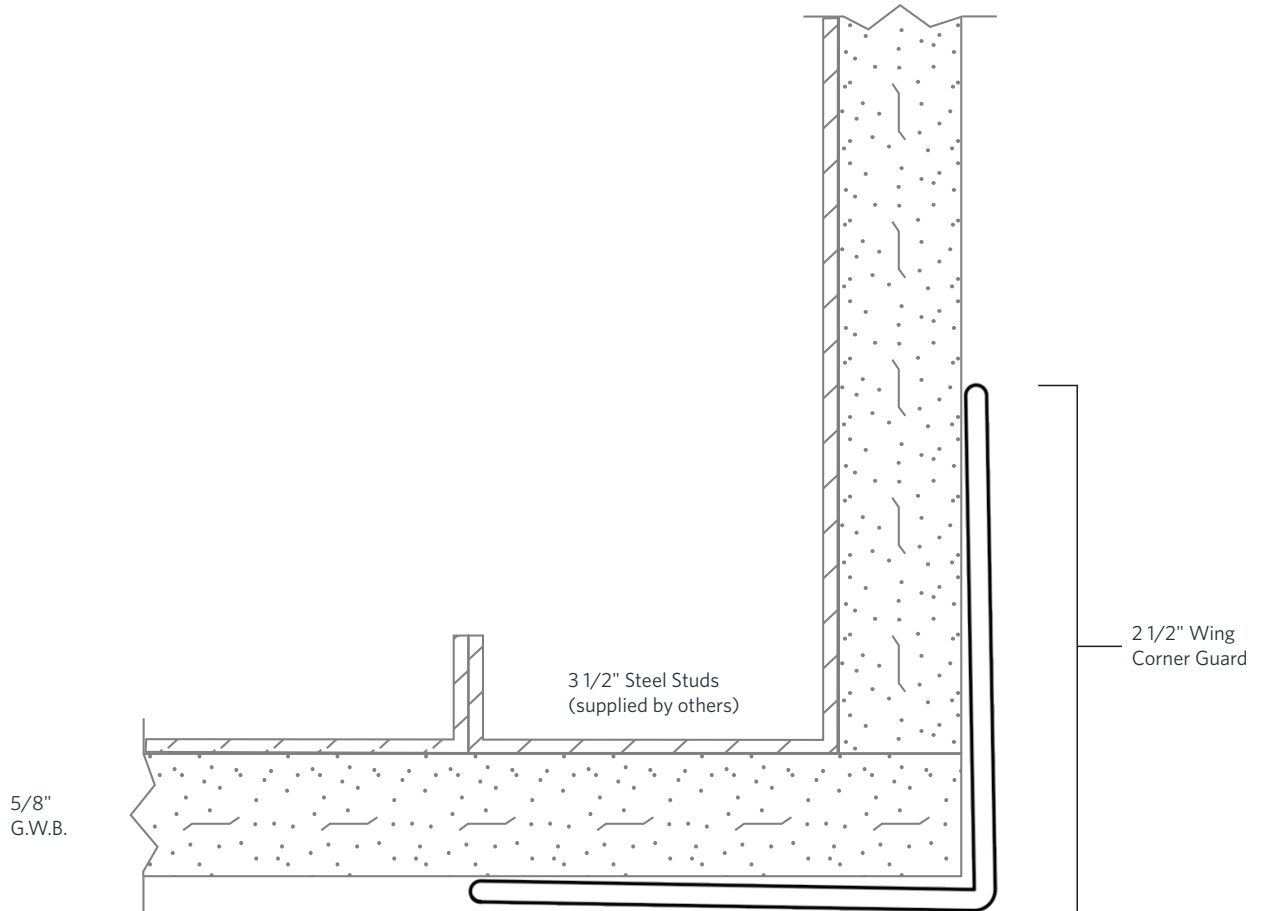

▶ 2" Colored Polycarbonate Corner Guards

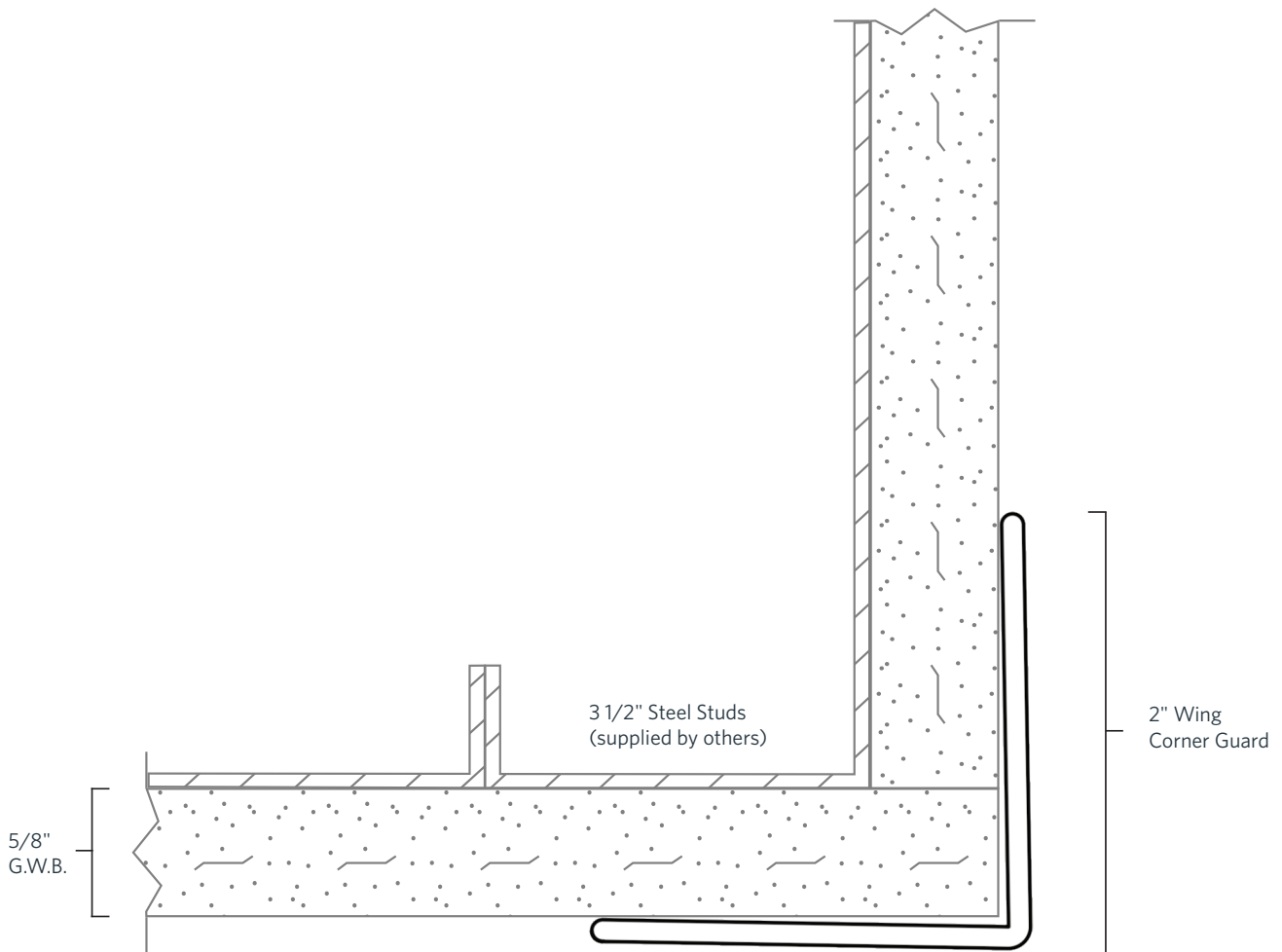

▶ 3" Colored Polycarbonate Corner Guards

