

# ▶ 3/4" Clear Polycarbonate Corner Guards

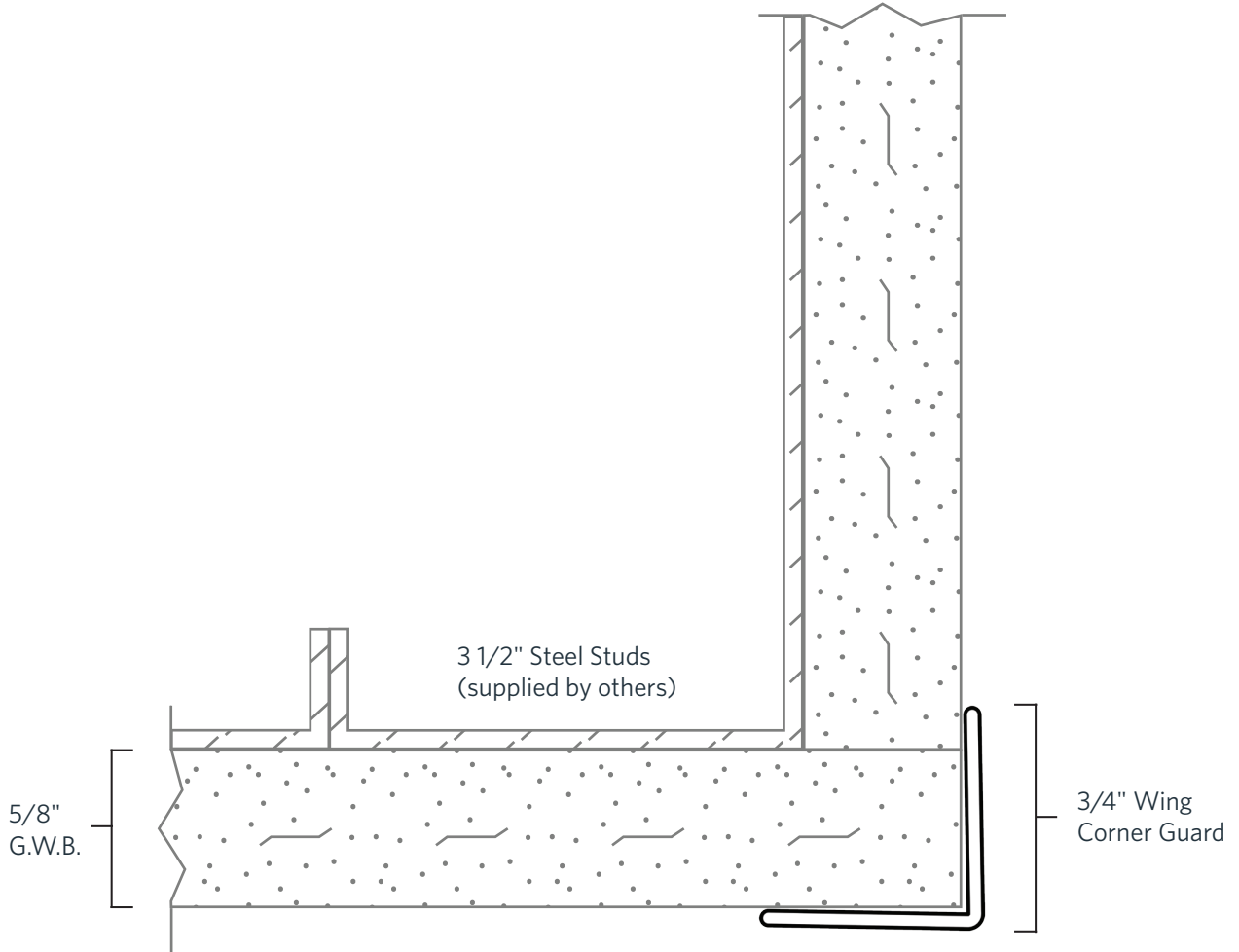

# ▶ 1 1/2" Clear Polycarbonate Corner Guards

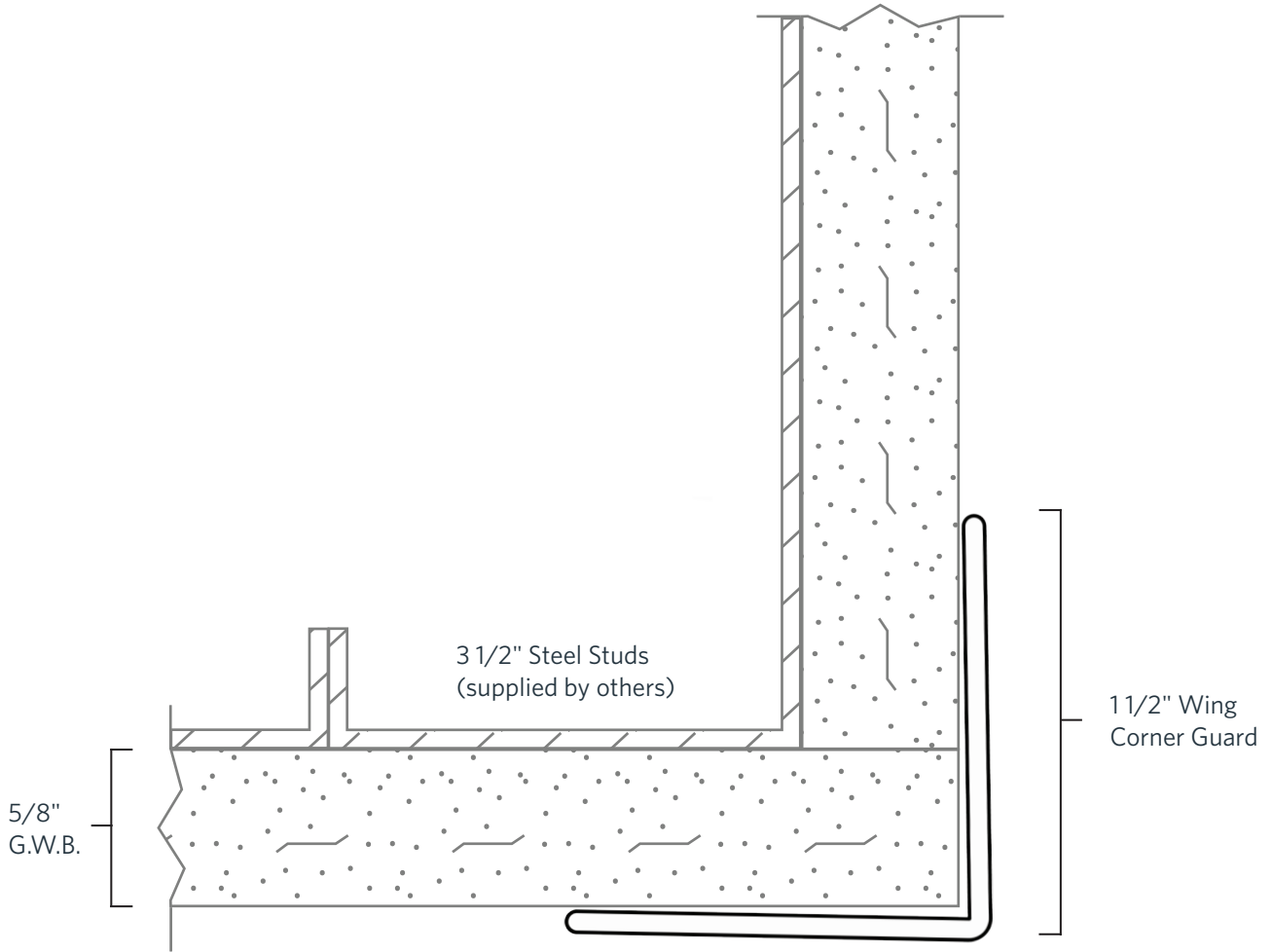

# ▶ 1 1/8" Clear Polycarbonate Corner Guards

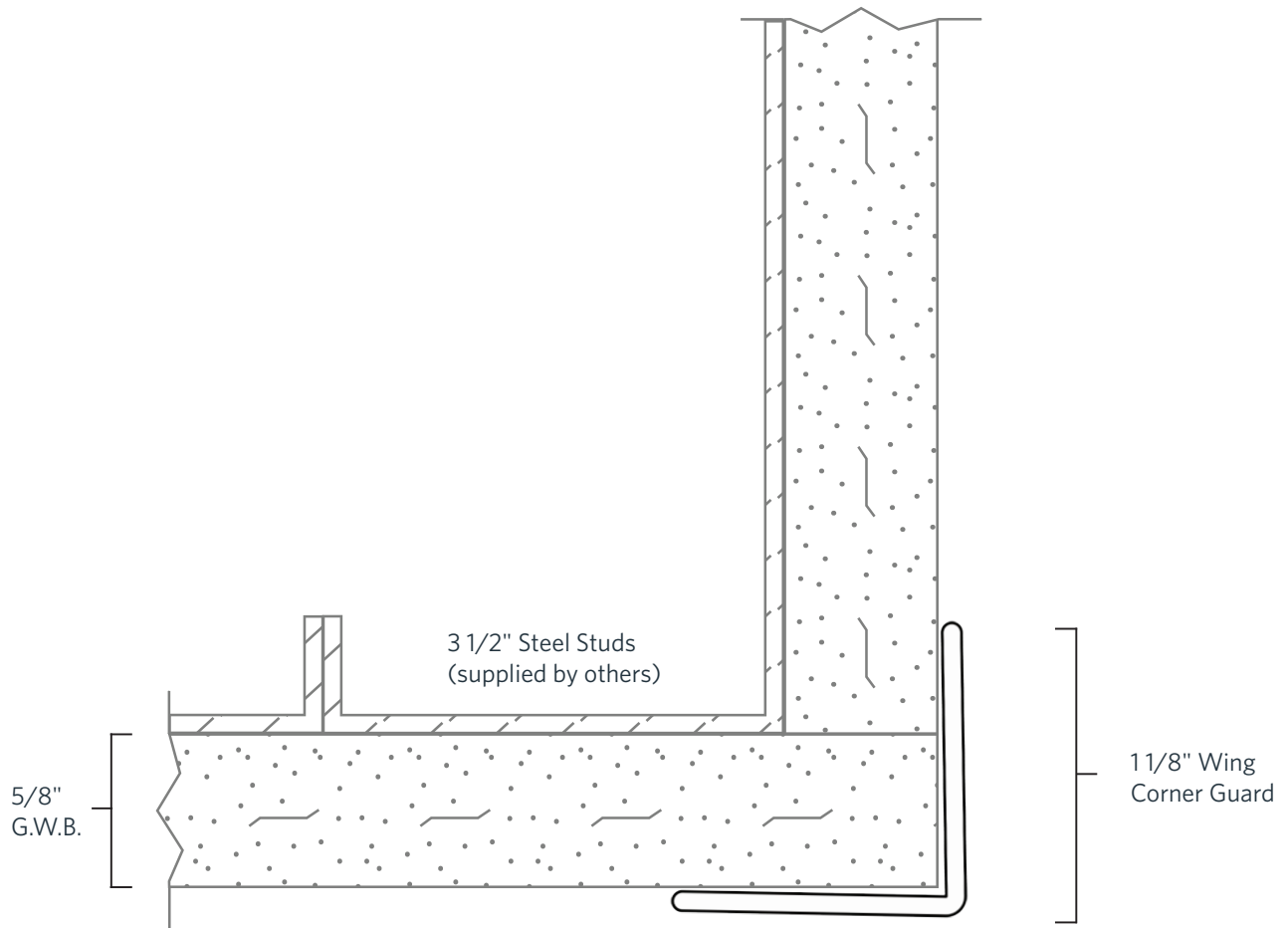

# ▶ 2 1/2" 135° Clear Polycarbonate Corner Guard

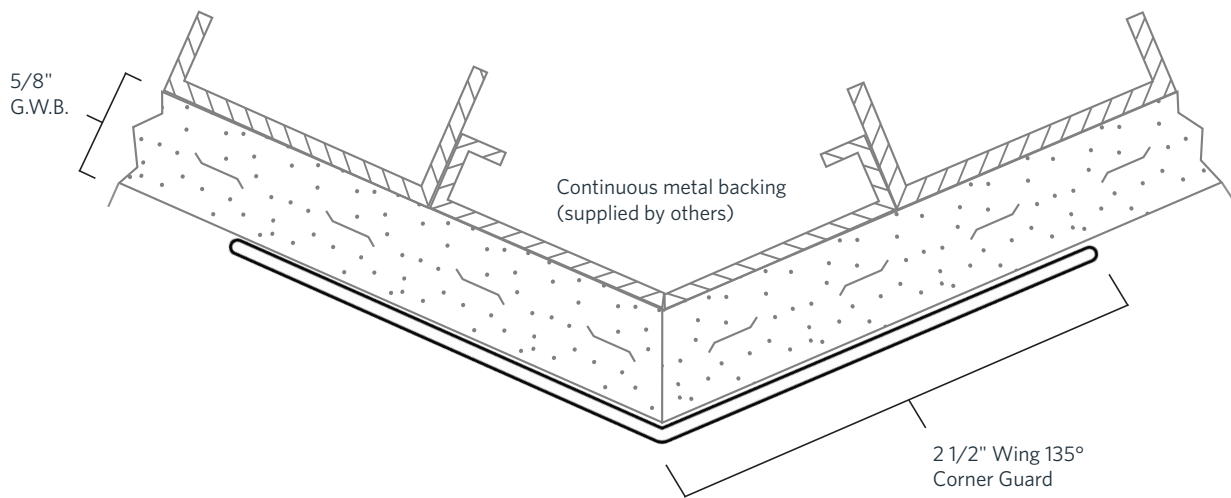

CAD DRAWING

# ▶ 2 1/2" Bullnose Clear Polycarbonate Corner Guards WX1

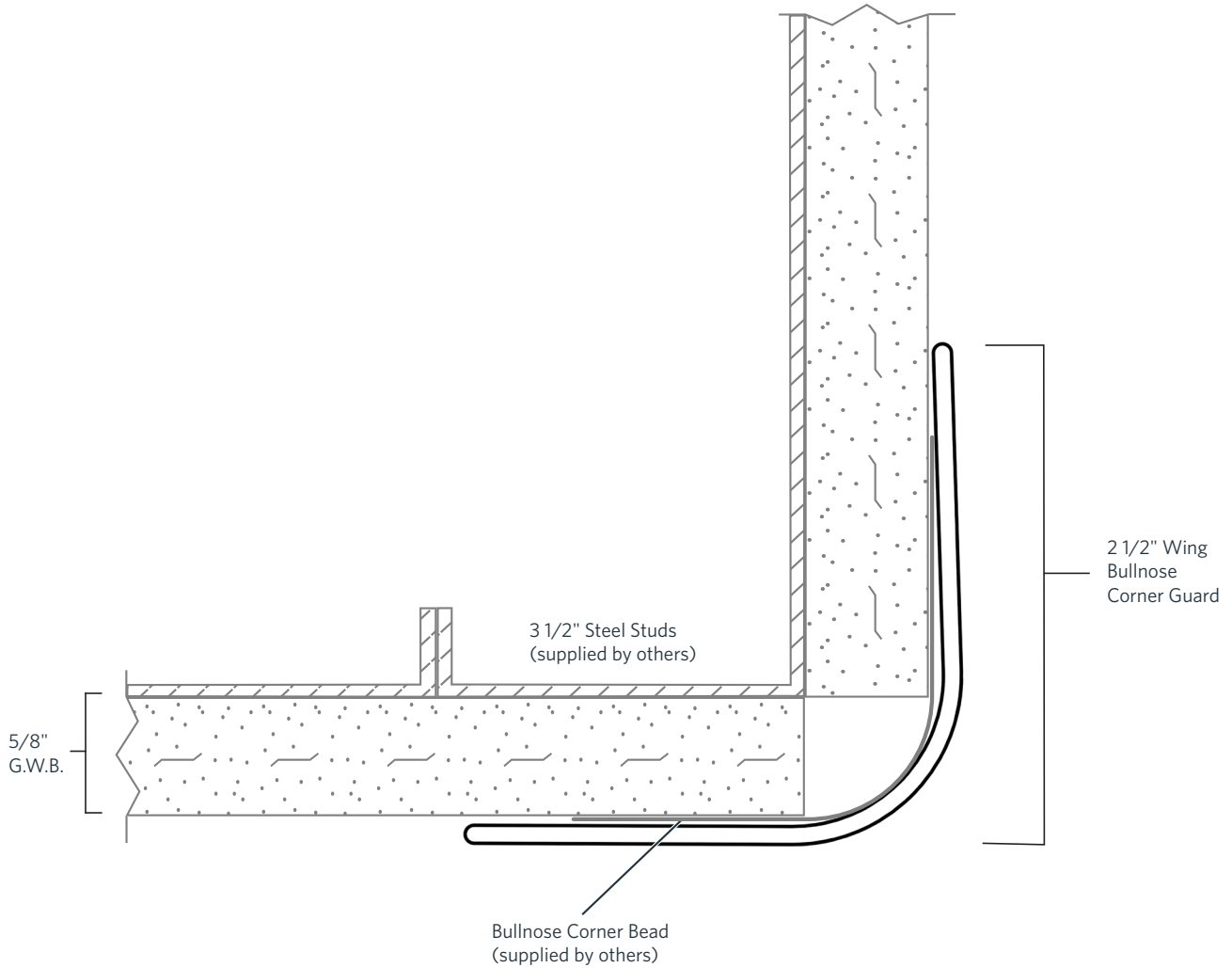

# ▶ 2 1/2" Clear Polycarbonate Corner Guards

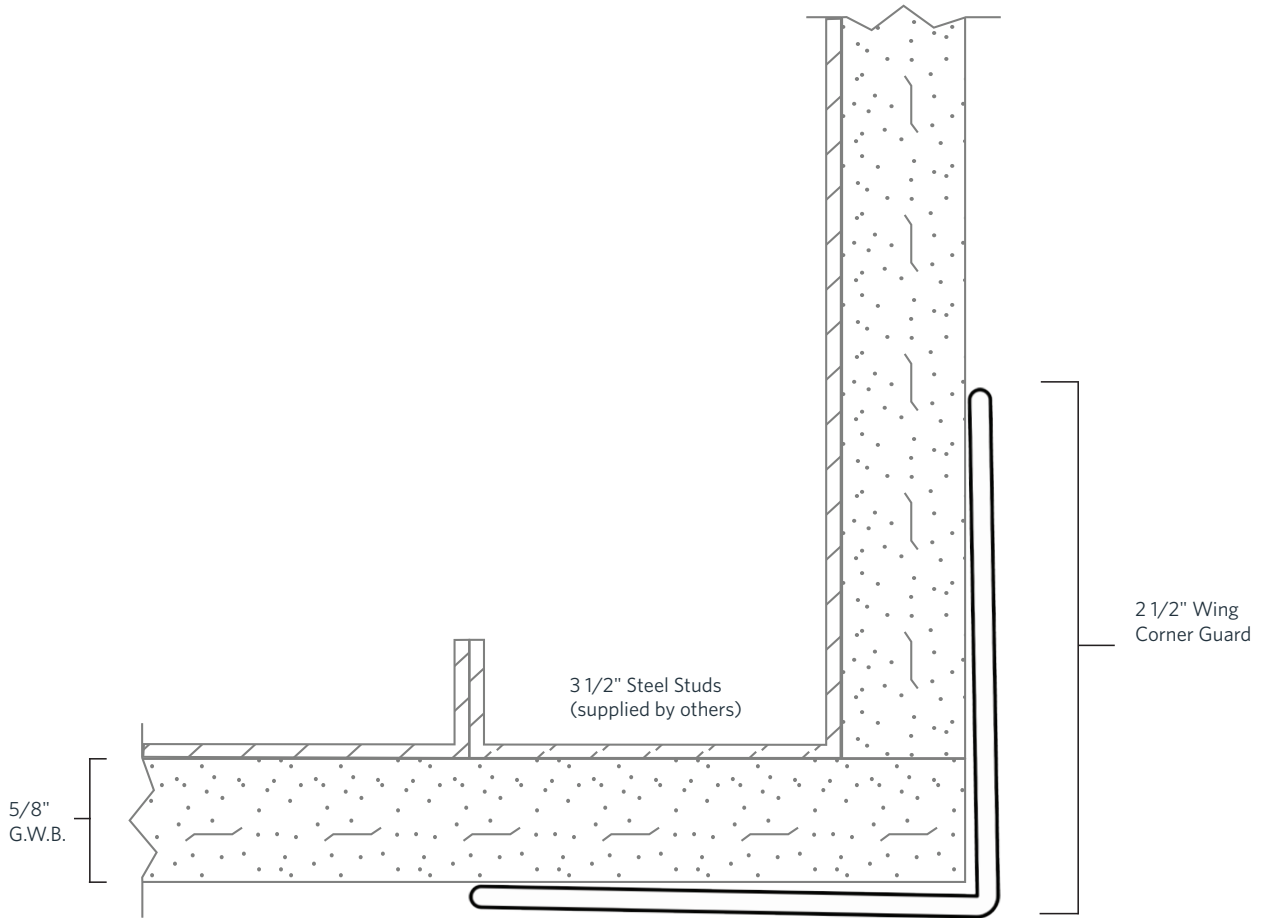

# ▶ 2" Clear Polycarbonate Corner Guards

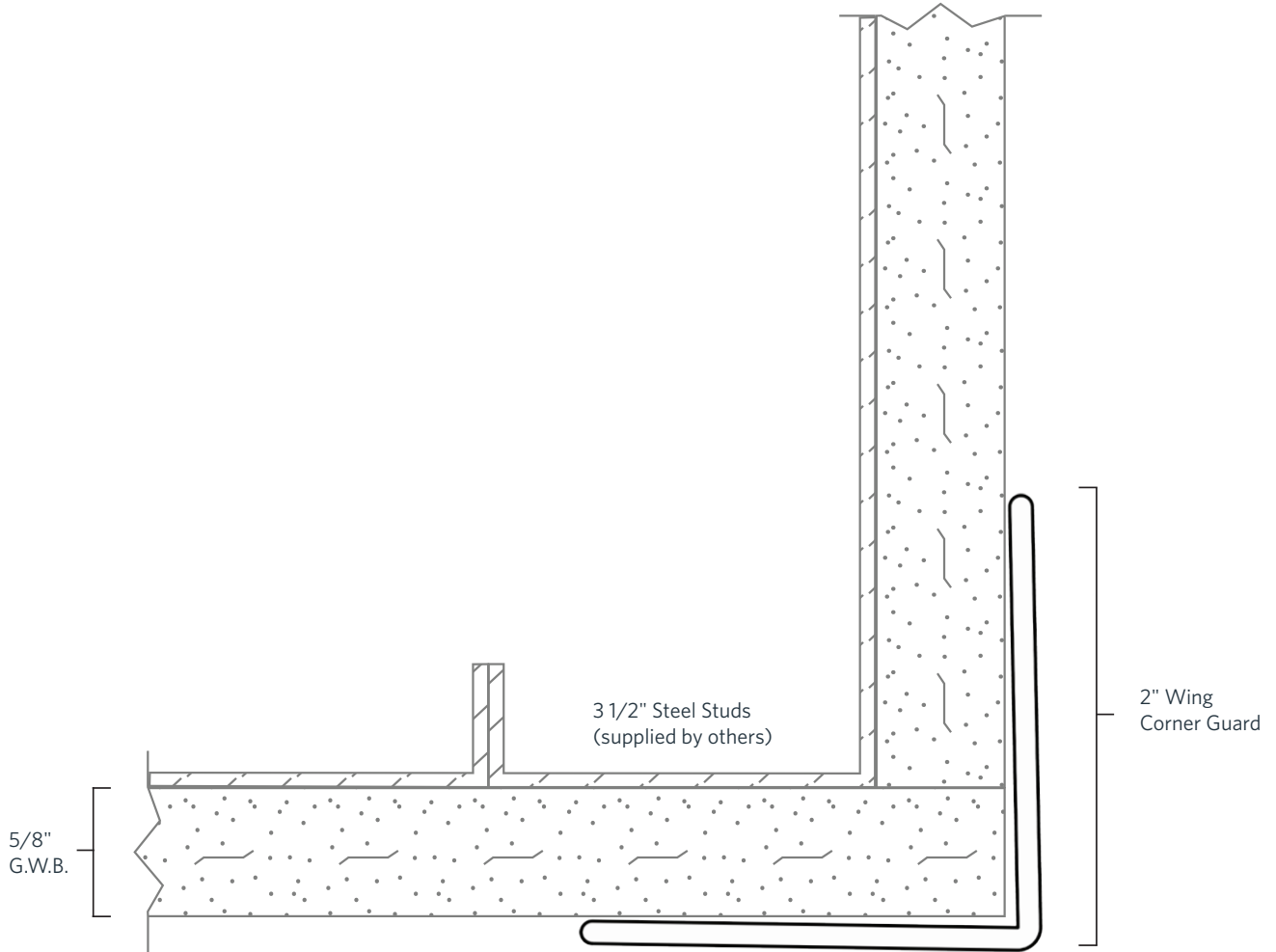

# ▶ 3" Clear Polycarbonate Corner Guards

