

Zip Block™ MODEL ZBSM 100 - 400 INSTALLATION INSTRUCTIONS

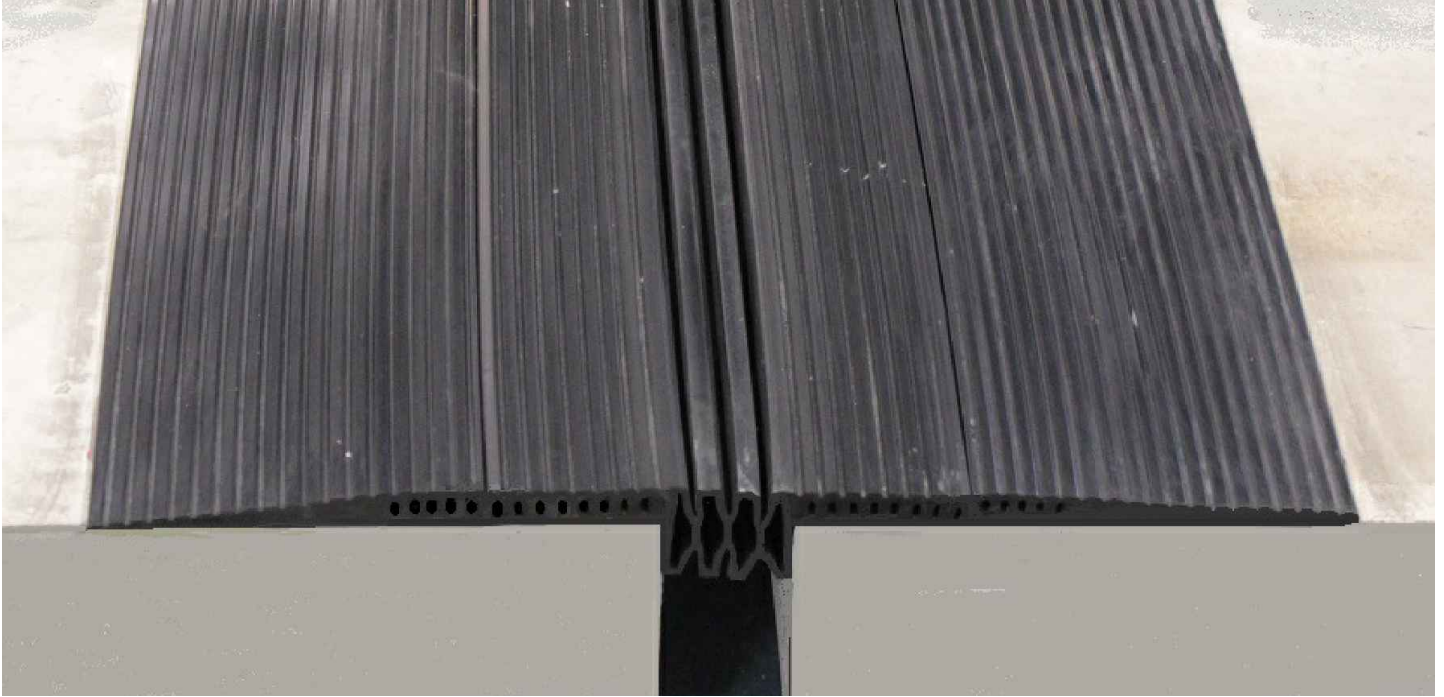

| | ZBSM-100 | ZBSM-200 | ZBSM-300 | ZBSM-400 |
|-----------------|----------|----------|----------|----------|
| EXPOSED SURFACE | 21.25" | 22.25" | 23.25" | 24.25" |
| JOINT WIDTH | 1" | 2" | 3" | 4" |

IMPORTANT INFORMATION

Prior to the commencement of Installation, all materials MUST be inspected for Damage. Any damage must be reported to CONSTRUCTION SPECIALTIES, INC., as soon as possible, so that replacement materials may be furnished without delay.

All work must be completed as per Architect's Approved "Shop Drawings", and in accordance with these Installation Instructions. When installation is complete, all materials must be protected from damage until the Architect's FINAL INSPECTION.

All materials should be arranged in the order that they are to be installed. All hardware required for each portion of the work should be placed with the appropriate materials.

Please review all Approved Shop Drawings and this Document to familiarize yourself with all the details and components of this assembly.

IMPORTANT:

READ THROUGH ALL INSTRUCTIONS PRIOR TO STARTING INSTALLATION

2/5/2024



Construction Specialties®

www.c-sgroup.com

6696 Route 405 Highway, Muncy, PA 17756
Phone: (800) 233-8493 / Fax: (570) 546-8022

This document is the property of Construction Specialties, Inc. and contains PROPRIETARY INFORMATION that is not to be disclosed to third parties and is not to be used without approval in writing from Construction Specialties, Inc.

© Copyright 2016 Construction Specialties, Inc.

GENERAL NOTES:

| Product Identification Table | |
|----------------------------------|----------------------------------|
| CS Call Out: | Product Name: |
| Epoxy | Pro Poxy 300 |
| Edge Sealant (Horizontal Joints) | Vulkem 45SSL (Horizontal Joints) |
| Edge Sealant (Vertical Joints) | NovaLink 35 (Vertical Joints) |
| Splice Sealant | Loctite 5900 |
| Instant Adhesive | 3M Scotch Weld |

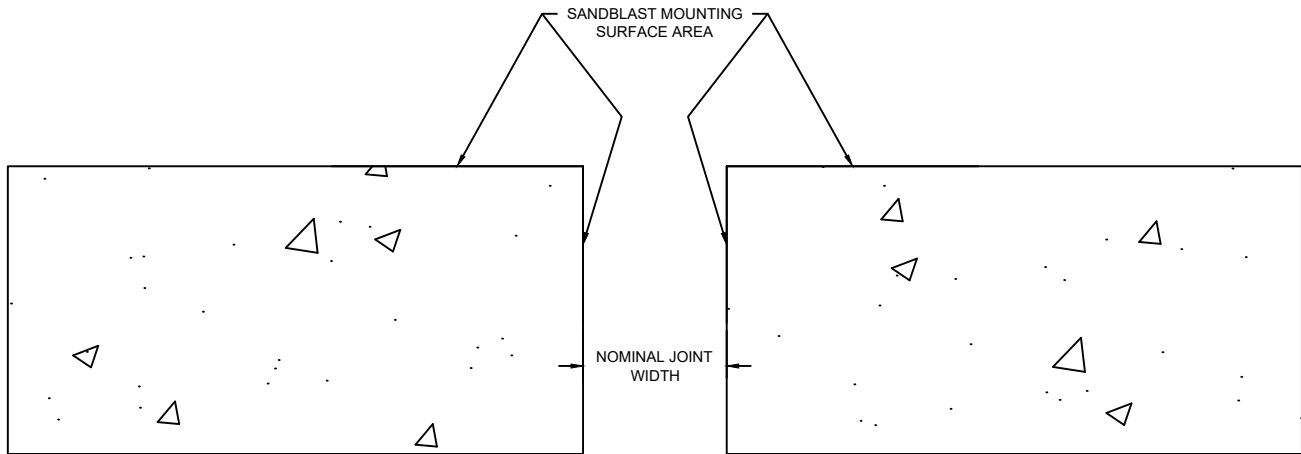

1. Before beginning installation of the ZB seal, review the layouts for the various runs of seal as detailed on the approved Construction Specialties shop drawings.
2. The "ZBSM" series compression seals must be securely mounted to structurally sound concrete that has cured for at least 7 days. Repair all damage to the mounting surface area before beginning installation.
3. The surface area in which the ZBSM seal is to be mounted must be flat, level and parallel. The mounting surface area must be flat (along the length of the joint) to within $\pm 1/8"$ and level (across the joint) to within $\pm 1/8"$.
4. The mounting surface area must be sandblasted to expose new concrete and remove all foreign materials.
5. The mounting surface area must be clean and free from any loose dust, dirt, debris and oils that would affect the installation of the seal, or adhesion of the epoxy. It is critical that the concrete mounting surface area adjacent to the joint is clean to allow the Epoxy to achieve the proper bond.
6. The ends, splices and transitions of the seal must be cut square and smooth to ensure a good seal. To aid in cutting the seal and wings for a straight clean cut it is best to build a jig to the joint width as installed. (See Fig. G.1)



(Fig. G.1)

GENERAL NOTES CON'T:

7. Place the seal into the jig and secure the jig with clamps. Spray the seal and the supplied saw blade with water, using long strokes while applying a downward force while cutting. (See Fig. G.2-G.4)
8. Mark the square cut ends of the seal to identify mating pieces. (See Fig. G.5)



(Fig. G.2)



(Fig. G.3)



(Fig. G.4)

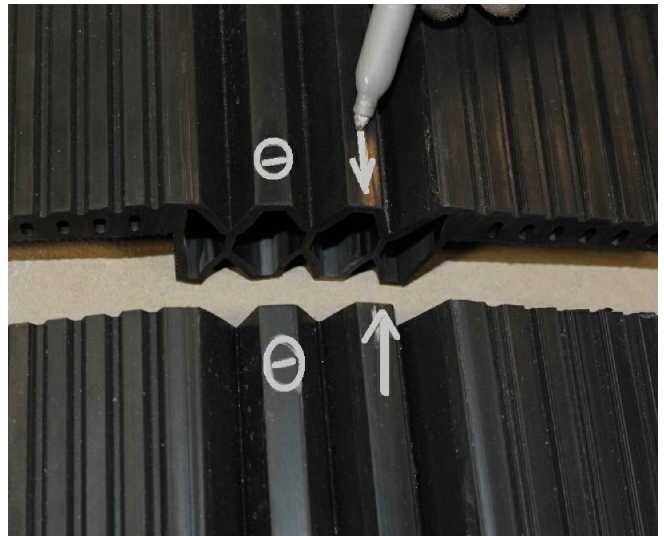

(Fig. G.5)

STEP 1

PREPARE SEAL

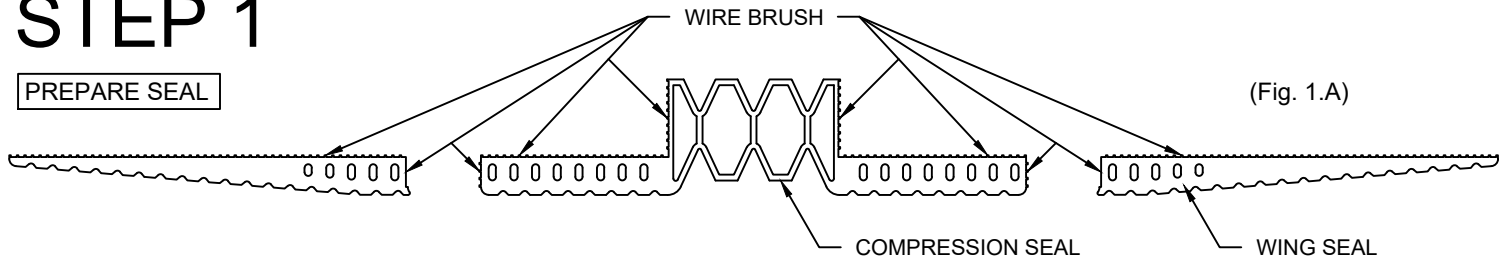

- 1.1) Unroll each length of compression Seal and Wing Seals. Lay each one upside-down on a flat surface.
- 1.2) Wire brush the bottom and sides of the Wings and sides of the compression Seal area thoroughly. Wire brushed areas should have a dull black appearance when finished. There should be no gloss or white residue left on these surfaces. Use a wire brush, drill or grinder with a wire wheel mounted in the chuck to achieve the dull finish. The epoxy may not bond properly if the Seal is not thoroughly wire brushed. (See Fig. 1.A-1E)
- 1.3) Clean the Seals thoroughly using compressed air to remove any loose rubber particles left behind from the wire brush. Wipe down Seal with Isopropyl Alcohol to remove any dirt or dust residue. (See Fig. 1.F)



(Fig. 1.B)

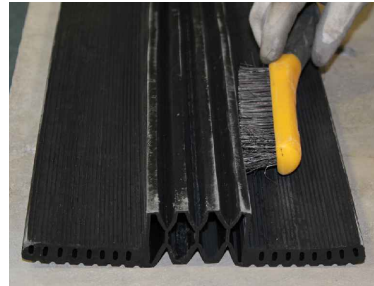

(Fig. 1.C)



(Fig. 1.D)

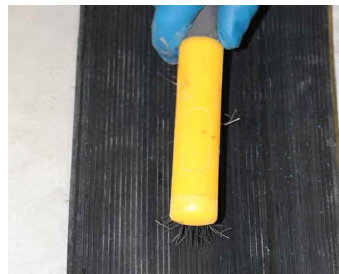

(Fig. 1.E)



(Fig. 1.F)

- 1.4) Place each length of cleaned Seal up-side down next to the joint area where it is to be installed. This will allow the Seal some time to flatten before it is bonded in place.

STEP 2

EPOXY AND SEAL INSTALLATION

***IMPORTANT NOTE:** Do not use Epoxy or install this Seal if either the substrate temperature or air temperature will drop below 40°F [5°C] during the installation or cure time of 8 hours.

- 2.1) Using the Seal Wing dimension measure from the joint edge over and mark the concrete slab. Using a chalk line snap a line along the marked location, for the full length of the run. Apply tape along the outside edge of the chalk line. Repeat for the opposite side of the joint. (See Fig. 2.A - 2.C)



(Fig. 2.A)



(Fig. 2.B)



(Fig. 2.C)

STEP 2 CON'T

EPOXY AND SEAL INSTALLATION

| APPROXIMATE WORK LIFE OF EPOXY | |
|--------------------------------|------------|
| TEMPERATURE | WORK LIFE |
| 50°F [10°C] | 35 MINUTES |
| 70°F [21.11°C] | 25 MINUTES |
| 85°F [29.44°C] | 20 MINUTES |

- 2.2) Mix the supplied 2 part Epoxy measuring equal amounts of Part A and Part B by volume. Pour both Part A and Part B into a container and mix thoroughly for three minutes until a uniform gray color is achieved. (See Fig. 2.D - 2.E) Do not mix in direct sunlight as this will decrease the work life of the Epoxy. Only mix the amount of Epoxy that can be used within its gel time (see chart for gel time based on temperature).
- 2.3) Apply the Epoxy onto adjacent surfaces of the joint edge to the tape line and approximately 1 1/2" down the vertical face of the joint. Spread the Epoxy with a trowel until it is approximately 1/16" - 1/8" thick. (See Fig. 2.F - 2.G) The Epoxy must be applied quickly to allow time for the Seal to be installed before it begins to gel. Once the Epoxy has begun to gel or get hot, a proper bond will not be achieved.



(Fig. 2.D)



(Fig. 2.E)



(Fig. 2.F)

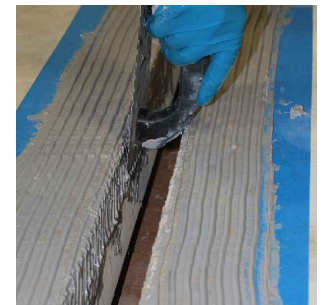

(Fig. 2.G)

- 2.4) Center the first section of the Seal over the joint and place the Wing on one side of the Seal into position. (See Fig. 2.H)
- 2.5) Starting at one end of the Seal, lift the Wing that was not previously seated, pushing inward on the Seal using a 1X board to compress the Seal to fit into the joint space. Have someone follow behind you walking on the Seal to seat it into place. (See Fig. 2.I - 2.J)
- 2.6) Remove the tape from the concrete areas. (See Fig. 2.K)
- 2.7) Place boards on the Seal the entire length of the Seal. Place concrete blocks, sand bags or something of similar weight, every couple of feet on top of the boards. This will force the Seal to set into the Epoxy during the cure cycle. *NOTE: This is especially important at splice locations, to be sure the ends of the Seal are flat and lined up. Allow the weights and boards to remain on the Seal for approximately 8 hours. (See Fig. 2.L)



(Fig. 2.H)

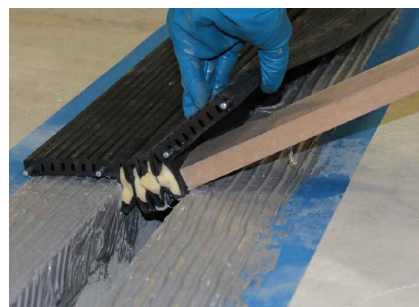

(Fig. 2.I)



(Fig. 2.J)



(Fig. 2.K)



(Fig. 2.L)

STEP 3

EPOXY AND WING SEAL INSTALLATION

***IMPORTANT NOTE:** Do not use Epoxy or install this Wing Seal if either the substrate temperature or air temperature will drop below 40°F [5°C] during the installation or cure time of 8 hours.

- 3.1) Place each length of the cleaned/wire brushed Wing Seal upside-down next to the joint area where it is to be installed. This will allow the seal some time to flatten before it is bonded in place. (See Fig. 3.A)
- 3.2) Check to ensure that the concrete is free from loose dirt, debris and oils. It is critical that the concrete mounting surface area adjacent to the joint is clean to allow the Epoxy to achieve the proper bond.
- 3.3) Using the Wing Seal dimension measure over from the installed seal and mark the concrete slab. Using a chalk line snap a line along the marked location, for the full length of the run. Apply tape along the outside edge of the chalk line. Repeat for the opposite side of the joint. (See Fig. 3.B - 3.D)
- 3.4) Mix the supplied, 2 component Epoxy measuring equal amounts of Part A and Part B by volume. Pour both Part A and Part B into a container and mix thoroughly for three minutes until a uniform gray color is achieved. Do not mix in direct sunlight as this will decrease the work life of the Epoxy. Only mix the amount of epoxy that can be used within its gel time (see chart for gel time based on temperature).
- 3.5) Apply the Epoxy onto the concrete surface from the installed edge of the seal to the tapped line of the Wing Seal. Spread the Epoxy with a trowel until it is approximately 1/16" - 1/8" thick. The Epoxy must be applied quickly to allow time for the Wing Seal to be installed before it begins to gel. Once the Epoxy has begun to gel or get hot, a proper bond will not be achieved.
- 3.6) Position a length of the Wing Seal as shown, duct tape the Wing Seal to the seal every foot or so. Place boards on the Wing Seals with concrete blocks, sandbags or something of similar weight every couple of feet on top the boards. This will force the Wing Seals to set into the Epoxy during the cure cycle to ensure it is properly seated. *NOTE: This is especially important at splice locations, to be sure the ends of the Wing Seals are flat and lined up. Allow the weights and boards to remain on the seal for approximately 8 hours. (See Fig. 3.E - 3.H)

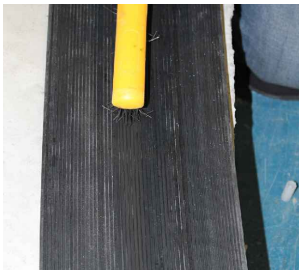

(Fig. 3.A)



(Fig. 3.B)



(Fig. 3.C)



(Fig. 3.D)



(Fig. 3.E)



(Fig. 3.F)

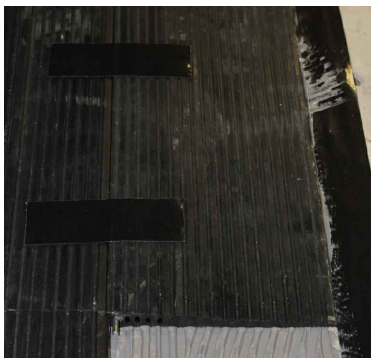

(Fig. 3.G)



(Fig. 3.H)

STEP 4

SEAL SPLICING AND INSTALLATION

*NOTE: SPLICE KITS SOLD SEPARATELY

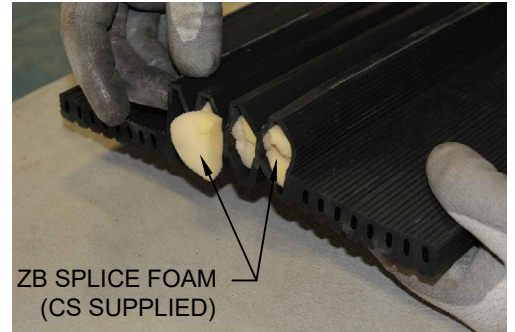
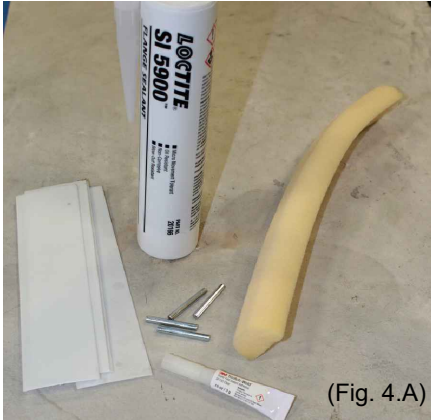

(Fig. 4.C)

4.1) Ensure that the Spliced ends of the next Seal are cut square and clean. To aid in cutting the Seal and Wing Seal it is best to build a jig to the joint width as installed. See The General Instruction notes at the beginning of the installation instructions.

4.2) Install a cut piece of supplied open cell Splice Foam in ends of ZBSM cell openings. (See Fig. 4.A - 4.C)

4.3) Apply the supplied instant adhesive to the grooved end of the alignment pin and place 1/2 of its length in the oval slot of the installed seal. Repeat this step until you have placed 4 alignment pins as shown in the seal. (See Fig. 4.D - 4.F)

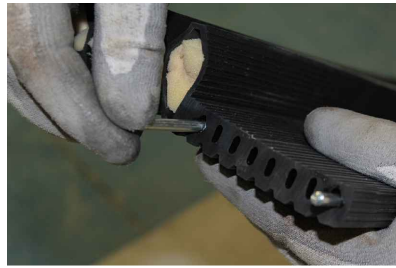

4.4) Apply the supplied Splice Sealant to the end of the previously installed section and the next section of seal to be installed. (See Fig. 4.G)

4.5) Follow Step 2 to mix and apply the epoxy to the adjacent surface of joint area for the next section of joint seal. Place the end of the next section of seal on the surface area adjacent to the joint and press the first 5-6 inches of the seal into the joint to align the alignment pins with the end of the previously installed section. Slide the seal against the end of the installed section so that the alignment pins slide into the corresponding cells. Ensure that there is not a gap between the ends of the seal. (See Fig. 4.H - 4.J) Center the remaining length of seal over joint and install according to Steps 2 & 3.

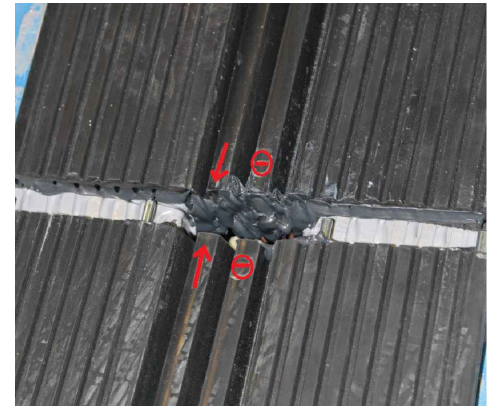
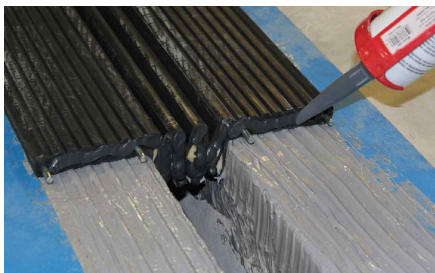

(Fig. 4.I)



(Fig. 4.J)

STEP 5

WING SEAL SPLICING AND INSTALLATION

*NOTE: SPLICE KITS SOLD SEPARATELY



(Fig. 5.A)



(Fig. 5.B)



(Fig. 5.C)

- 5.1) Apply the supplied instant adhesive to the grooved end of the alignment pin and place 1/2 of its length in the oval slot of the installed Wing Seal closest to the Compression Seal wing. (See Fig. 5A)
- 5.2) Follow Step 2 to mix and apply epoxy for the next section of Wing Seal installation.
- 5.3) Apply the supplied Splice Sealant to the end of the next section of Wing Seal to be installed. Place the end of next section of Wing Seal against the end of the installed section so that the alignment pin will slide into the corresponding cell. Ensure that there is no gap between the end of the Wing seal. (See Fig.5.B - 5.C)
- 5.4) Install the remaining length of Wing Seal according to Step 3.

STEP 6

SPLICING INSTALLATION

- 6.1) From the centerline of the splice measure back 2" from the centerline on both sides of the seal and mark. (See Fig. 6.A - 6.B)
- 6.2) At the Splice location wire brush to the 2" marked line on seal to create a rough surface. This will ensure that the seal surface and splice sealant have a good bond. Wire brushed areas should have a dull black appearance when finished. Clean the seal thoroughly using compressed air to remove any loose rubber particles left behind from the wire brush. (See Fig. 6.C)
- 6.3) Apply 2" wide tape, both sides of the splice, along the top surface of the seal approximately 2" away from the joint splice. Using a putty knife tuck the tape down into the seal valleys of the main seal at the joint space. (See Fig. 6.D)



(Fig. 6.A)



(Fig. 6.B)

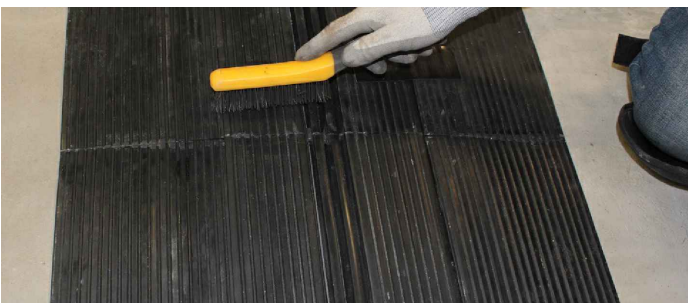

(Fig. 6.C)



(Fig. 6.D)

STEP 6 CON'T

SPLICING INSTALLATION

- 6.4) Install a second piece of 2" tape overtop of the first tape line. Add a piece of 2" tape along the side edges of the wing seal to minimize and contain the Splice Sealant along the edge. (See Fig. 6.E - 6.F)
- 6.5) Apply the supplied Splice Sealant into the valleys of the main seal, filling the V's and any other voids. (See Fig. 6.G)
- 6.6) Apply Splice Sealant in a zigzag pattern across the splice area, between the two tape lines. Apply sufficient amounts of Splice Sealant to create, when smoothed out, an approximate thickness of 1/8" to 3/16". Use a putty knife to smooth out the supplied Splice Sealant evenly over the entire width of the seal. (See Fig. 6H - 6I)



(Fig. 6.E)



(Fig. 6.F)

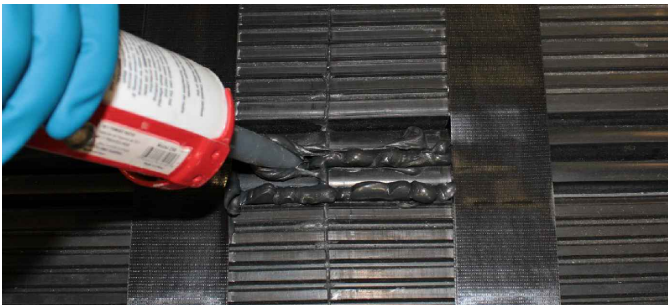

(Fig. 6.G)



(Fig. 6H)



(Fig. 6.I)

- 6.7) Carefully remove the tape from the seal along the splice joint. (See Fig. 6.J)
- 6.8) Place supplied pieces of 2" x 6" polyethylene strips, found in the hardware kit, into the V's to prevent them from sticking together during the cure time. Allow the Splice Sealant to cure for 24-48 hours, depending on temperature, keeping all vehicles away from the splice minimizing the amount of movement of the seal. (See Fig. 6.K)



(Fig. 6.J)

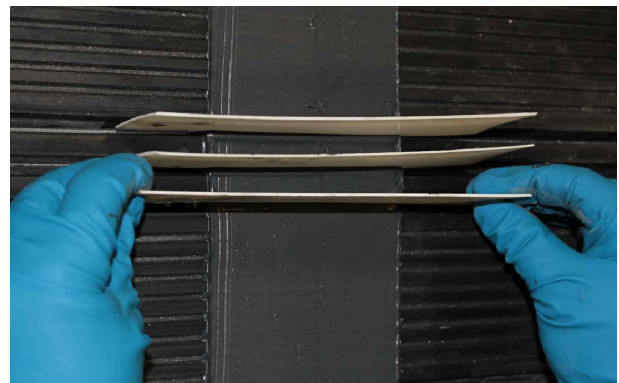

(Fig. 6.K)

STEP 7

ANGLED INTERSECTION

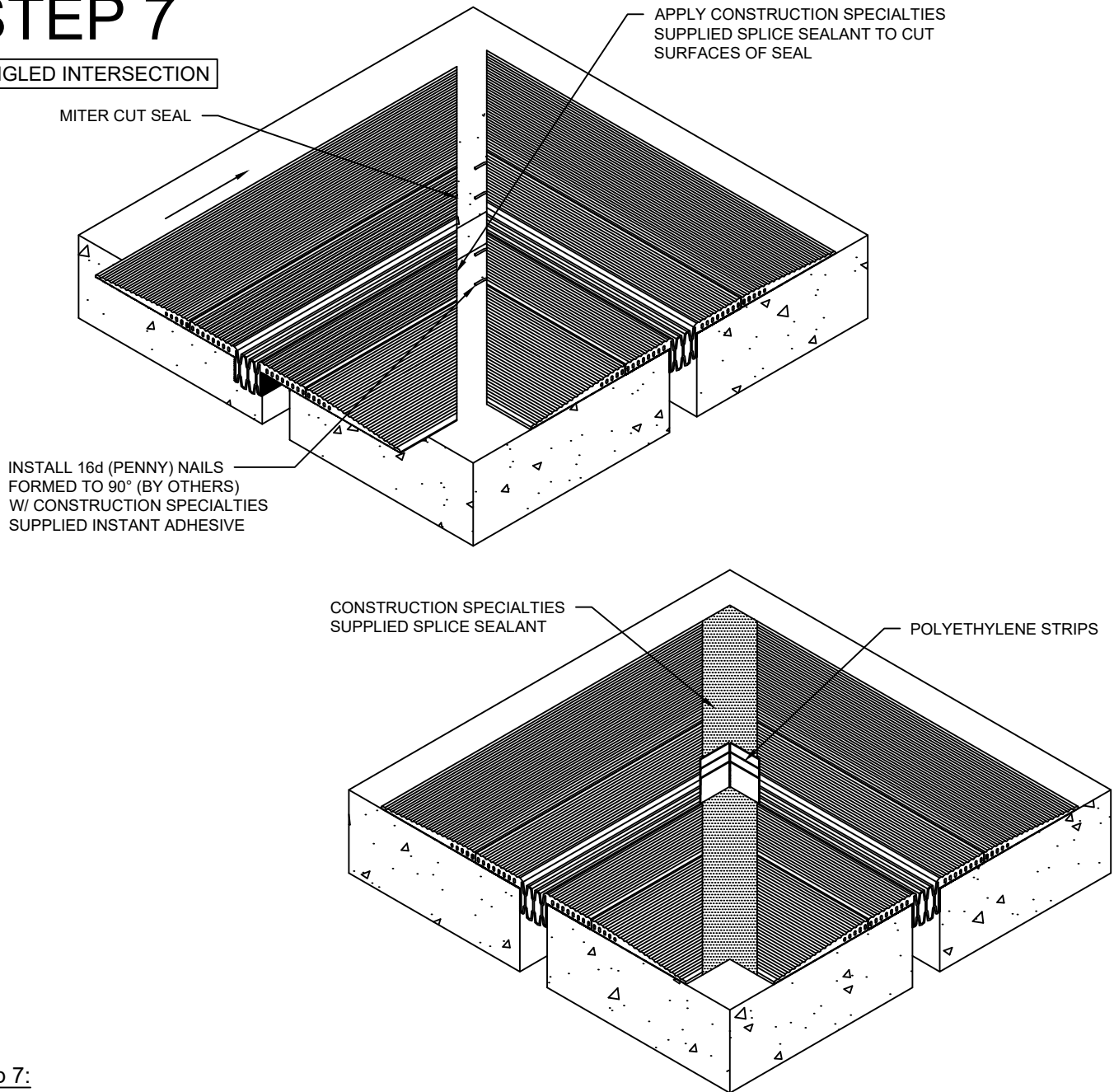

Step 7:

- 7.1) Miter the ends of the seals to the proper angle while compressed to the proper joint width.
- 7.2) Install the first section of seal and wings according to Steps 1 through 6. Ensure that the miter cut end is at the proper location.
- 7.3) Install the 16d (PENNY) 90° formed nails with the Construction Specialties supplied instant adhesive in the end of the installed seal.
- 7.4) Apply the Construction Specialties supplied Splice Sealant to the cut end of the installed seal.
- 7.5) Follow Step 2 to mix and apply the Epoxy to the adjacent surfaces of the next section of joint.
- 7.6) Center the end of the next section of seal over the joint and press the first 5-6 inches [127.00mm-152.40mm] of the seal into the joint to align with the alignment pins in the previously installed section.
- 7.7) Slide the seal against the end of the installed section so that the PENNY nails slide into the corresponding cells. Ensure that there is not a gap between the ends of the seals.
- 7.8) Center the remaining length of seal over the joint and install the seal and wings according to Steps 2, 3 and 4.
- 7.9) Apply more Construction Specialties supplied Splice Sealant over the top of the splice in accordance with Step 6.

STEP 8

T-INTERSECTION

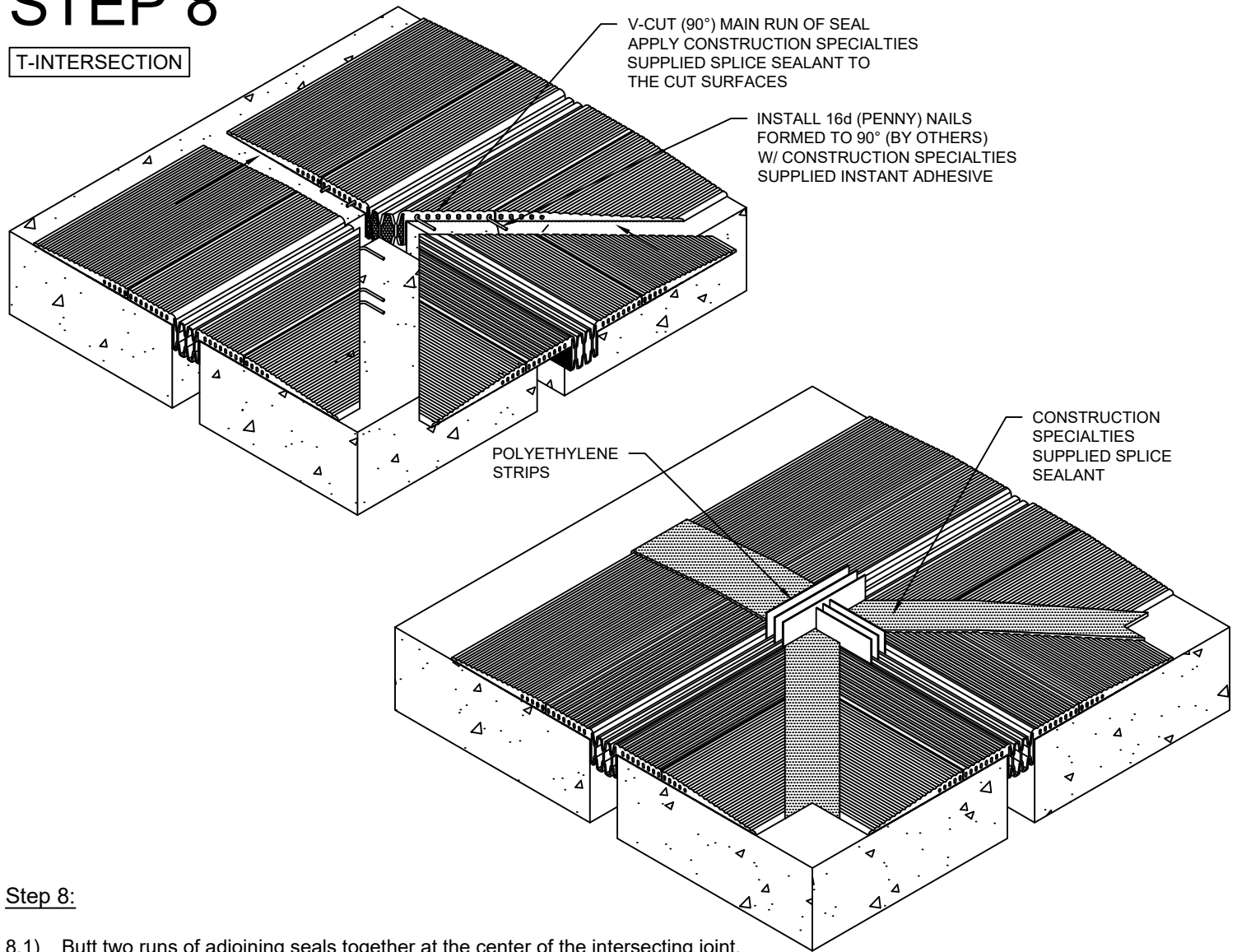

Step 8:

- 8.1) Butt two runs of adjoining seals together at the center of the intersecting joint.
- 8.2) Make a 45° cut through half the adjoining seals while compressed to the proper joint width as shown above.
- 8.3) Apply Construction Specialties supplied Splice Sealant to cut ends of the seals.
- 8.4) Slide the seal against the previously installed seal so that the 16d (PENNY) 90° formed nails slide into the corresponding cells. Ensure that there is not a gap between the ends of the seals.
- 8.5) V-cut the end of the mating seal so that both seals will fit together properly.
- 8.6) Install the 16d (PENNY) 90° formed nails with the Construction Specialties supplied instant adhesive in the end of the installed seal.
- 8.7) Apply the Construction Specialties supplied Splice Sealant to the cut end of the installed seal.
- 8.8) Follow Step 2 to mix and apply the Epoxy to the mounting surface area of the next section of joint.
- 8.9) Center the end of the next section of seal over the joint and press the first 5-6 inches [127.00mm-152.40mm] of the seal into the joint to align with the alignment pins in the previously installed section.
- 8.10) Slide the seal against the V-cut of the installed section so that the 16d (PENNY) 90° formed nails slide into the corresponding cells. Ensure that there is not a gap between the seals.
- 8.11) Center the remaining length of seal over the joint and install seal and wings according to Steps 2, 3 and 4.
- 8.12) Apply more Construction Specialties supplied Splice Sealant over the top of the splice in accordance with Step 6.

STEP 9

CROSS INTERSECTION

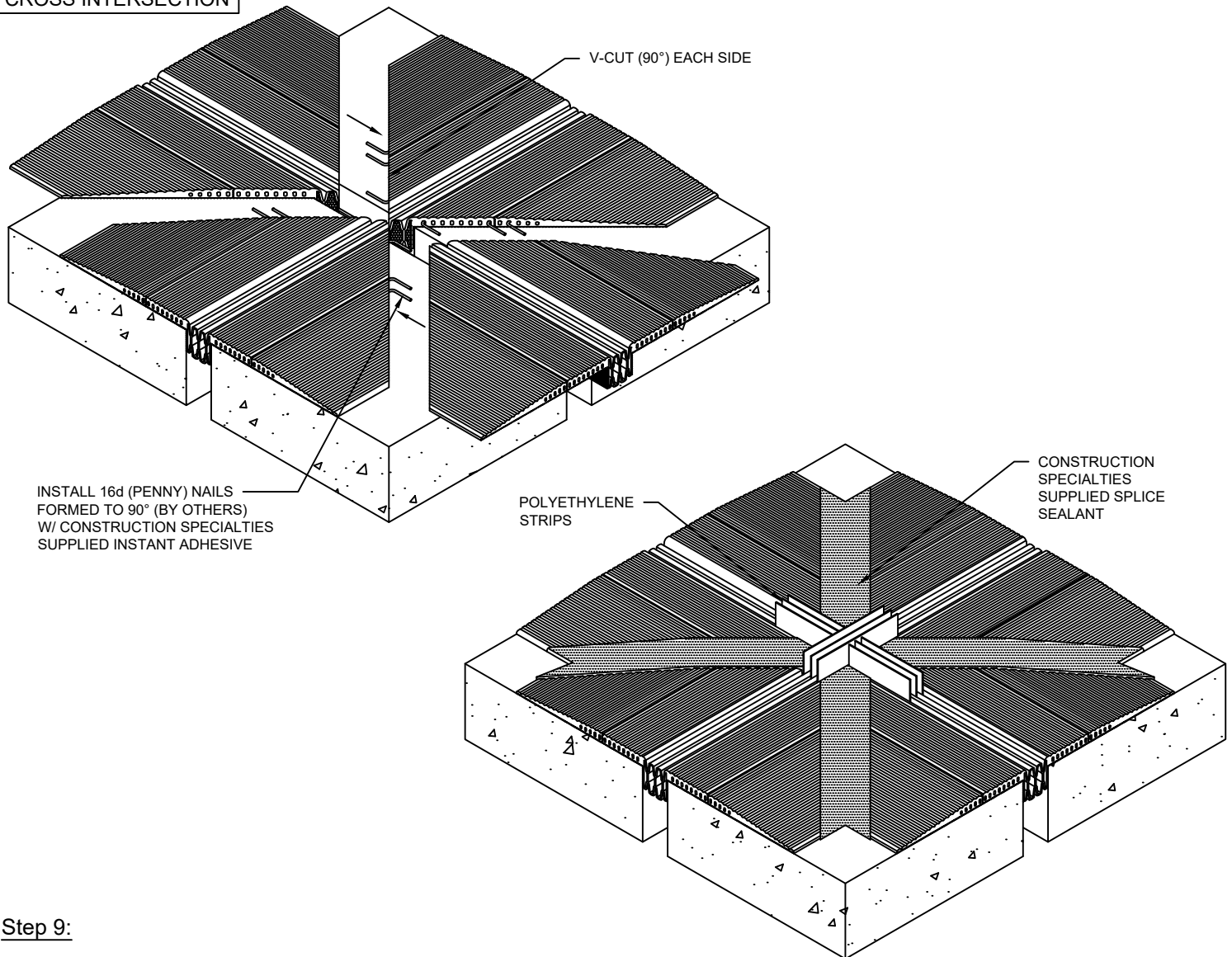

Step 9:

- 9.1) V-cut each side of the main run of seal at the joint intersection while compressed to proper joint width as shown above.
- 9.2) V-cut the ends of the mating sections of seal to allow them to fit properly with the main run.
- 9.3) Install the 16d (PENNY) 90° formed nails with the Construction Specialties supplied instant adhesive in the V-cuts of the main run of seal.
- 9.4) Apply the Construction Specialties supplied Splice Sealant to the cut end of the installed seal.
- 9.5) Mix the Epoxy and apply it to the mounting surface areas as outlined in Step 2.
- 9.6) Center the end of the next section of seal over the joint and press the first 5-6 inches [127.00mm-152.40mm] of the seal into the joint to align with the alignment pins in the previously installed section.
- 9.7) Slide the seal against the end of the installed section so that the 16d (PENNY) 90° formed nails slide into the corresponding cells. Ensure that there is not a gap between the ends of the seals.
- 9.8) Center the remaining length of seal over the joint and install the seal and wings according to Steps 2, 3 and 4.
- 9.9) Repeat the above steps to install the opposite side of the cross intersection.
- 9.10) Apply more Construction Specialties supplied Splice Sealant over the top of the splice in accordance with Step 6.

STEP 10

VERTICAL TRANSITION

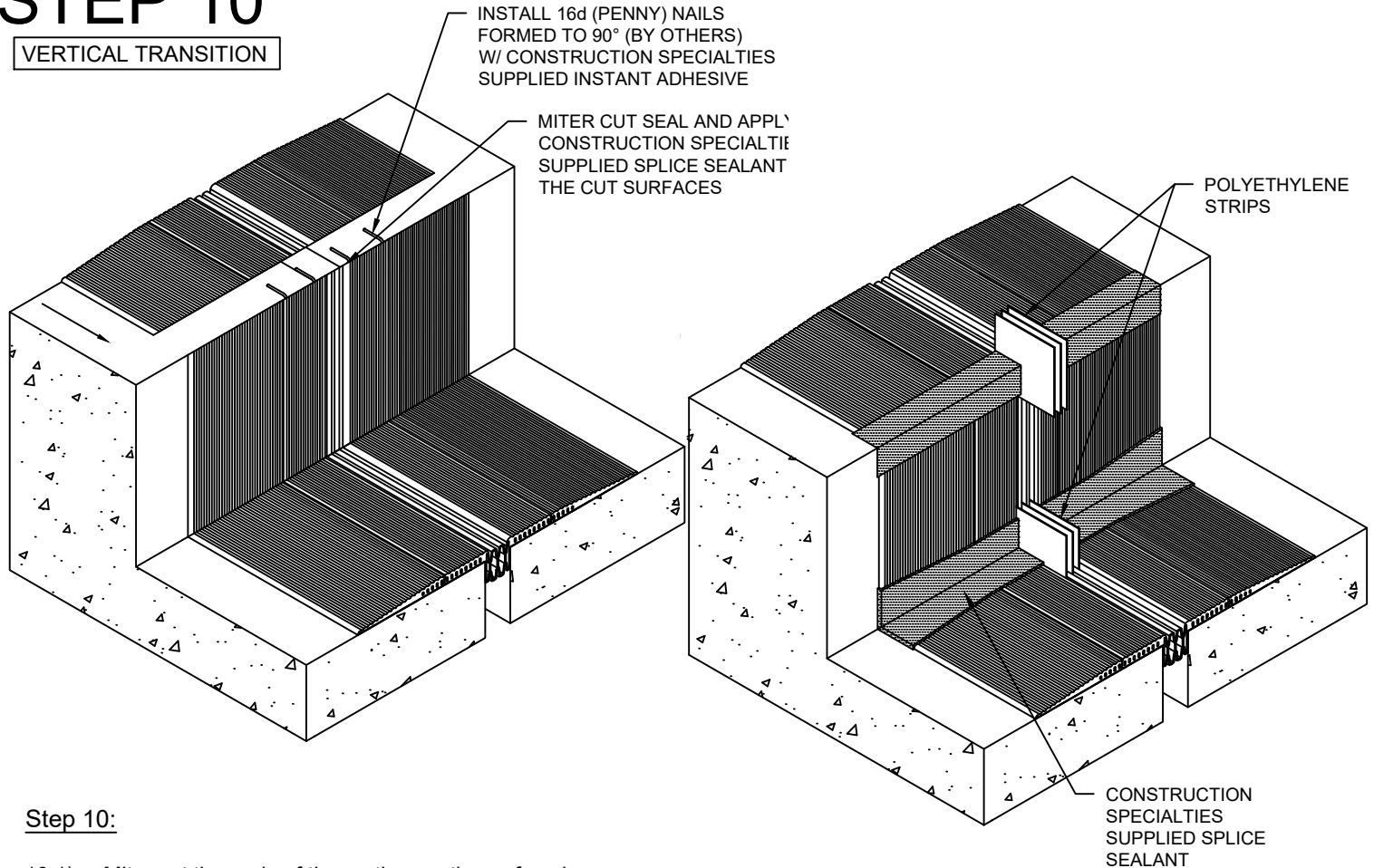

Step 10:

- 10.1) Miter cut the ends of the mating sections of seal.
- 10.2) Install 16d (PENNY) 90° formed nails in the bottom horizontal section of seal using the Construction Specialties supplied instant adhesive.
- 10.3) Install the bottom horizontal run of seal following Steps 1 through 4. Ensure that the mitered end of the seal is located properly in the joint.
- 10.4) Apply the Construction Specialties supplied Splice Sealant to the cut end of the seal.
- 10.5) Mix the Epoxy and apply it to the vertical mounting surface areas as outlined in Step 2.
- 10.6) Install the vertical run of seal in the joint following Steps 1 through 4. Ensure that the 16d (PENNY) 90° formed nails are properly seated within the corresponding cells.
- 10.7) Apply more Construction Specialties supplied Splice Sealant over the top of the splice.
- 10.8) Install 16d (PENNY) 90° formed nails in the top of the vertical seal using the Construction Specialties supplied contact cement.
- 10.9) Apply the Construction Specialties supplied Splice Sealant to the cut end of the vertical seal.
- 10.10) Mix the Epoxy and apply it to the mounting surface areas as outlined in Step 2.
- 10.11) Center the end of the top horizontal section of seal over the joint and press the first 5-6 inches [127.00mm-152.40mm] of the seal into the joint to align with the alignment pins in the previously installed section.
- 10.12) Slide the seal against the end of the installed section so that the 16d (PENNY) 90° formed nails slide into the corresponding cells. Ensure that there is not a gap between the ends of the seals.
- 10.13) Center the remaining length of seal over the joint and install according to Steps 2, 3 and 4.
- 10.14) Apply more Construction Specialties supplied Splice Sealant over the top of the splices in accordance with Step 6.

STEP 11

TRANSITIONS

FLOOR TO WALL TRANSITION WITH WING INTACT

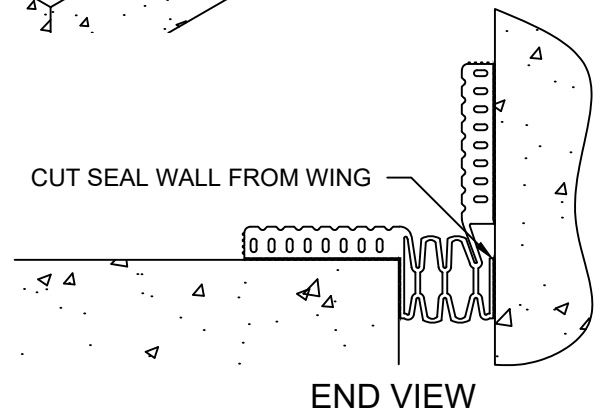
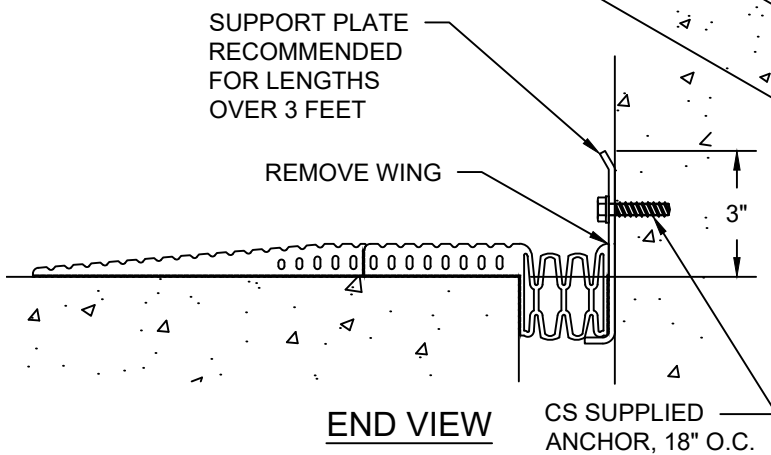
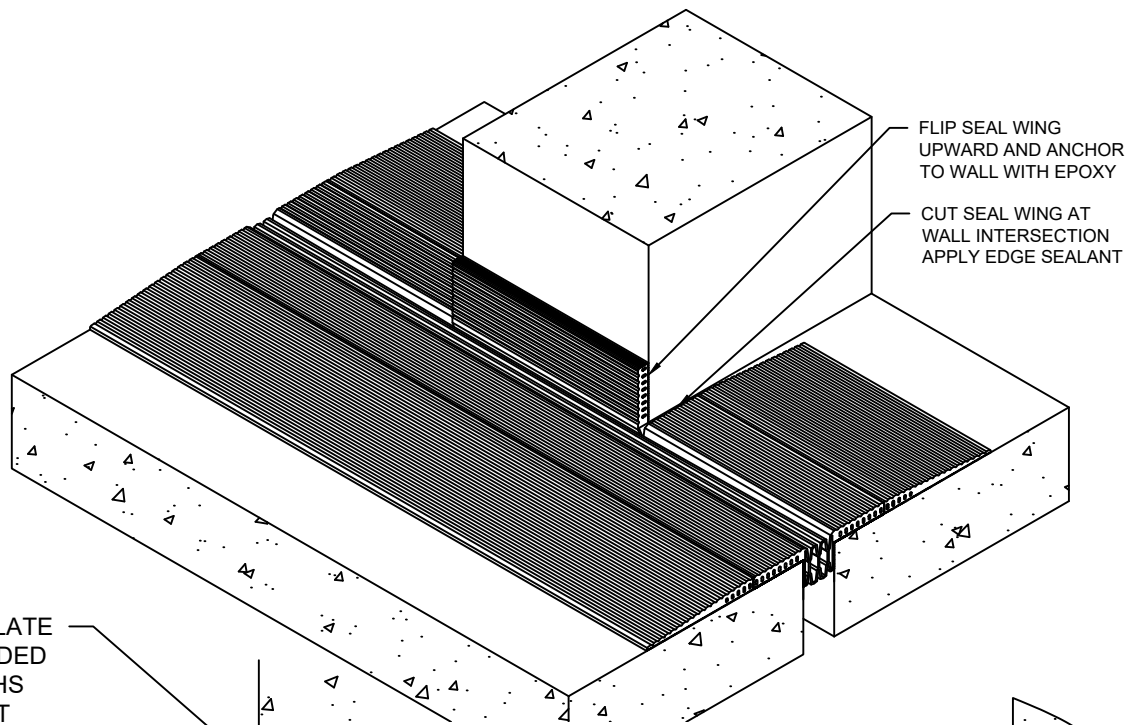

FLOOR TO WALL TRANSITION WITH WING REMOVED (RECOMMENDED)

Step 11:

- 11.1) Cut through the width of the wing in the location where the seal will intersect a wall. Also, use a utility knife to cut the seal wall from the wing on the section to be flipped upward.
- 11.2) Install the run of seal according to Steps 1 through 6. Ensure that the cut sections of wing are flipped upward at the wall locations.
- 11.3) Apply Epoxy to the face of the wall where the wing will be located.
- 11.4) Place a weight, 4" x 4" [101.60mm x 101.60mm] lumber or equivalent object against the vertical wing to hold it in place until the epoxy cures.
- 11.5) Use the supplied Splice Sealant to cover any gaps or tears in the seal created by the transition.
- 11.6) Use the supplied Edge Sealant to fill any gaps between the substrate and seal created by the transition.

(RECOMMENDED OPTION):

- 11A.1) If using a support plate, install it using the CS supplied anchors in accordance with the anchor manufacturers instructions. The plate is to be installed so that the top edge is 3" above concrete floor.
- 11A.2) Wipe down the aluminum Wall Angle at the seal location with alcohol or xylene to remove any dirt/grease before applying . Let dry before installing seal.
- 11A.3) Remove the sections of wing where the seal will intersect a wall. Install the epoxy and seal according to steps 1 through 6. Be sure to apply Epoxy to the vertical face of the support plate to ensure the seal is bonded.

STEP 12

TRANSITIONS

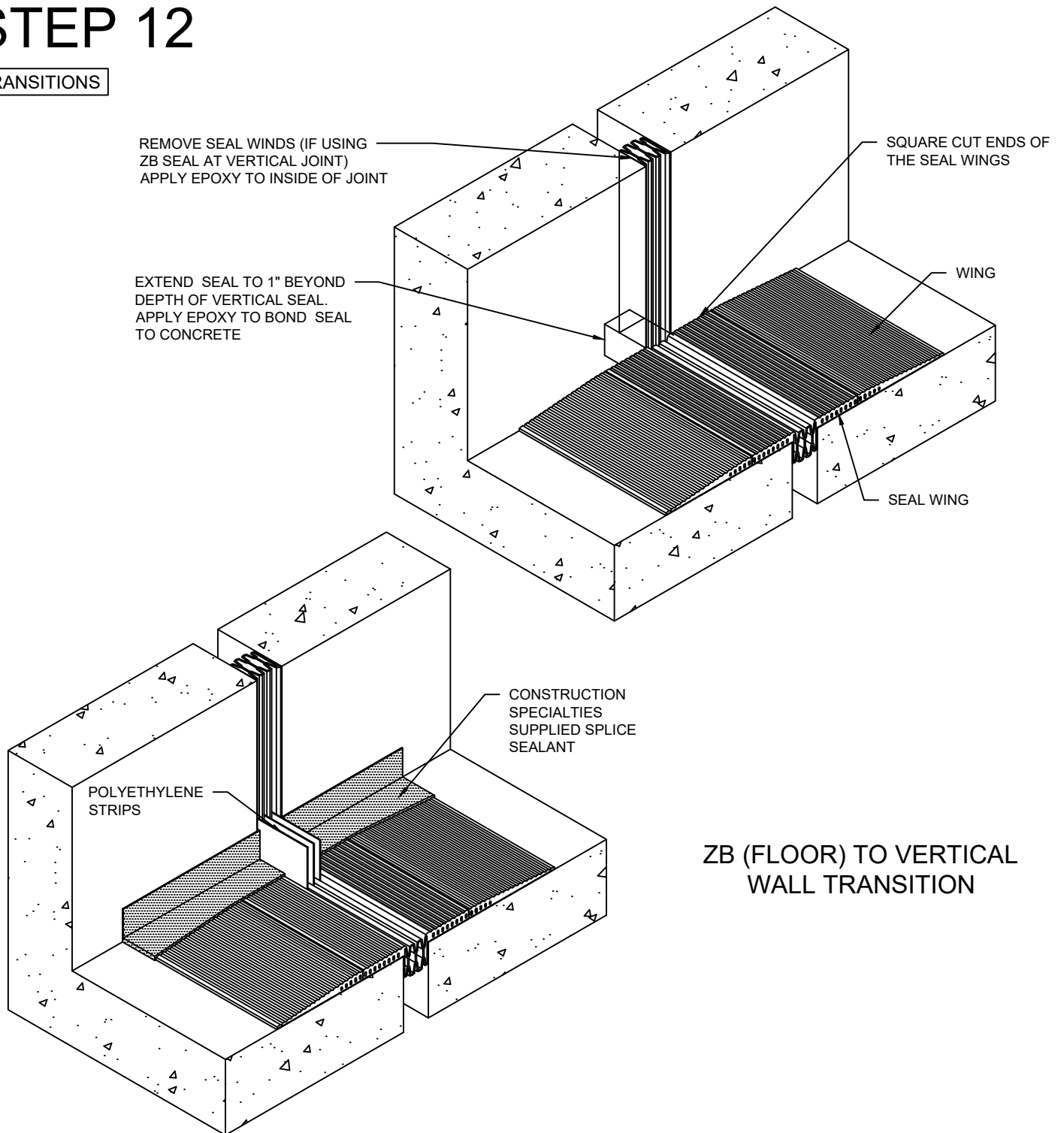

Step 12:

- 12.1) Remove wings at wall and install seal through wall to 1" beyond the depth of wall seal.
- 12.2) Install the main run of seal and wings according to Steps 1 through 6.
- 12.3) Apply the Construction Specialties supplied Splice Sealant to the area where the vertical seal will intersect with the horizontal seal.
- 12.4) Apply Epoxy to the walls of the vertical joint where the seal will be installed.
- 12.5) Press the seal into the vertical joint. Be sure to maintain a tight fit at the intersection.
- 12.6) Apply Construction Specialties supplied Splice Sealant over the top of the splice.

STEP 13

COMPLETE INSTALLATION

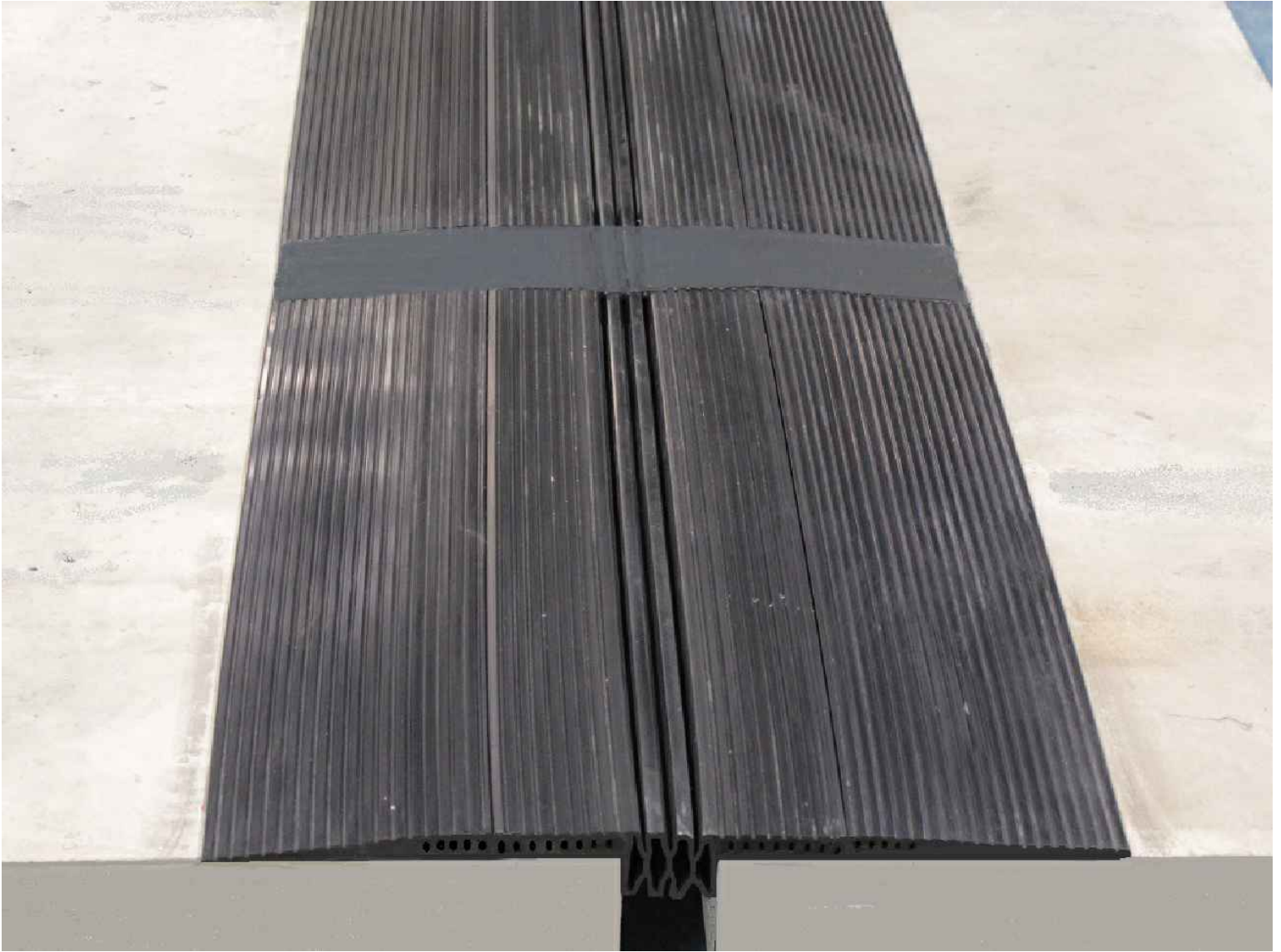

Step 13:

- 13.1) Remove all tape from the seal and concrete. If required, clean tape residue off of seal with denatured alcohol.
- 13.2) The ZBSM installation is now complete.
- 13.3) Clean and protect the Seal until Architect/Owner's final approval.